



30+ MILLION

SAFE & HAPPY FAMILIES

WORLD WIDE



LPG
ACCESSORIES

ADAPTERS

VALVES

FITTINGS

HOSES

IGT SAFETY ACCESSORIES FOR **LPG GAS APPLIANCES**

Caravan, Boat and Leisure housing
as well as professional installations



CONTENT

01 ABOUT US

02 SALES NETWORK

03 CATALOGUE OVERVIEW (A - NV)

04 NOTES

ABOUT US



DENMARK

Welcome to Integrated Gas Technologies, (Denmark)

Ningbo Shuai Xian Regulator Co. Ltd. (China)

Integrated Gas Controls Technologies Pvt. Ltd. (India)

IGT (Integrated Gas Technologies) is a gas control equipment company excelling in manufacturing and marketing of LPG cylinder safety device, cylinder valves and equipment accessories. All together the two founders have 40 years of solid experience in the global LPG safety device business.

History & Strategy

Before IGT entered the market in 2004 most markets had two offerings; either an expensive European made LPG regulator of good quality, with a minimum 5 year life cycle or alternatively a cheap "copy" LPG regulator of very poor and dangerous quality. IGT now serves the global market with the best of the two worlds by offering a significantly flexible product at a very attractive price. Our safety device are always 100% tested, clearly bar coded as well as safe and sound products, we will always strive to deliver freight and duty paid and on time no matter the location in the world.

Vision & Mission

Our vision is to create Gas Technology that makes life better and safer for everyone, everywhere — every person, every family, and every community around the globe. This motivates us — inspires us — to do what we do. To make what we make. At IGT we "Strive for perfection" this motto summarises how IGT is focused on bringing well designed, perfectly assembled professionally packaged products to the market.



CHINA



INDIA

IGT WORLD WIDE



SALES NETWORK OVER 110 COUNTRIES



IGT is a global supplier of domestic LPG Safety Device, with sales in over 110 countries.

IGT has a worldwide distribution sales network with own sales staff in Europe, United States, Latin, America/Peru, Russia-SNG countries, China and India.

See complete distributor and dealer list on WWW.IGT-LPG.COM

-  **Headquarters: Denmark**
-  **Factory: Ningbo China, Hyderabad India**
-  **Sales Office: Russia, Peru, USA, Kenya**

IGT EU GAS FITTINGS, VALVES & HOSES

- *Applications: Gas appliances, Caravan, Boat and Leisure housing as well as professional installations*
- *In EU there are over 50 different gas cylinder valve connections, gas pressures and outlet sizes-hoses etc.*
- *IGT is committed in assisting by this catalogue to make a clear overview of the combined solutions available to the market.*

A GAS CYLINDER ADAPTORS

B HOSE ADAPTORS

C HOSE EXTENSION PIECES

D PIPE TO HOSE ADAPTORS

E HOSE NOZZLES - TWO PIECE METAL
METAL CONICAL CONNECTION

F GAS FILTERS

G HOSE ASSEMBLY EXTENSIONS

H SIZE REDUCTION ADATOR

I POL ADAPTORS

J PLUGS

K NUT AND NIPLE PARTS

L SLEEVES AND CLAMPS

M COMPRESSION FITTINGS EN8434

N TOOLS

P PIPE -PIPE EXTENSIONS FITTINGS

Q QUICK COUPLINGS EN561

S SAFETY EXCESS FLOW VALVES

CH CHANGE OVER VALVES

BV BALL VALVES

NV NEEDLE VALVES

Notes:

G.xx Refers to Inner or Outer Thread according to ISO228-1

G.1 Threaded connection W20 x 1,814 L.H,

G.2 Threaded connection W21,8 x 1,814 LH 60°

G.3 Threaded connection M16 x 1,5 R.H.

G.4 Thread connection W21,8 x 1,814 L.H - 55°

G.5 Thread connection W21,8 x 1,814 L.H - 55°

G.6 Thread connection W22 x 1,155 L.H.

G.7 Thread connection 5/8 L.H. -POL

G.8 Thread connection W21,8 x 1,814 - L.H.

G.9 Thread connection 0,880 NGO L.H. - US POL

G.10 Threaded connection 0,880 NGO L.H. - Rubber Nose - US POL

G.12 Threaded connection W21,8 x 1,814.LH 55

- Compression Fittings Supplied are made to EN8434.
Unless specifically stated.
G1/4" and G3/8" LH threads and made to EN560



A	B	Material	Factory Item No.	IGT DK Item No.
M14x1,5	M16x1,5 female	Brass	QJCP000039	A900-258

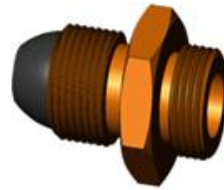

A	B	Material	Factory Item No.	IGT DK Item No.
G10 male	G2 male	Brass	QJCP000039	A900-090



A	B	Material	Factory Item No.	IGT DK Item No.
G10 male	M16x1,5 female	Brass	QJCP000163	A900-089



A	B	Material	Factory Item No.	IGT DK Item No.
G10 male	G12 male	Brass		A900-048



A	B	Material	Factory Item No.	IGT DK Item No.
G10 male	M14x1,5 90 degree angled	Brass		A900-078



A	B	Material	Factory Item No.	IGT DK Item No.
G10 male	G3/8" LH male	Brass		A900-259



A	B	Material	Factory Item No.	IGT DK Item No.
G5/8 female	G2 female	Brass	QJCP000040	A900-091



A	B	Material	Factory Item No.	IGT DK Item No.
G10 female	G2 female	Brass	QJCP000094	A900-107

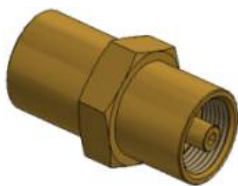

A	B	Material	Factory Item No.	IGT DK Item No.
G10 female	G12 female	Brass	QJCP000162	A900-111

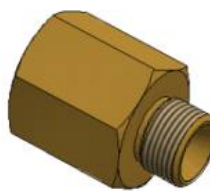

A	B	Material	Factory Item No.	IGT DK Item No.
G10 female	G3/8" LH male	Brass		A900-260



A	B	Material	Factory Item No.	IGT DK Item No.
G12 male	G2 female	Brass	QJCP000041	A900-092
G1 male	G2 female	Brass	QJCP000050	A900-097
G2 male	G12 female	Brass	QJCP000043	A900-094
G8 male	G2 female	Brass	QJCP000045	A900-096

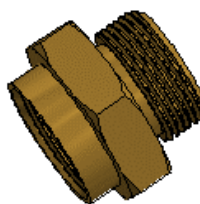

A	B	Material	Factory Item No.	IGT DK Item No.
G2 male	G1 female	Brass	QJCP000044	A900-095



A	B	Material	Factory Item No.	IGT DK Item No.
G5 female	W21.8 x 1.814 LH male	Brass	QJCP000154	A900-158



Description	Material	Factory Item No.	IGT DK Item No.
G5 female	1/4" NPT male	Brass	QJCP000155

- GAS Cylinder Adaptors are used to bridge the Various hose and regulator combination to the various gas cylinder valve outlets.
- For Quick connecting click-on and compact valve adaptors check out our LPG regulator catalogue. (C235is & C100)
- IGT Cylinder Adapter set D700 contains 12 adaptors enabling a Caravan/Boat user to connect to any gas cylinder in Europe

HOSE ADAPTORS

B



Description	Material	Factory	IGT DK
		Item No.	Item No.
G3/8" LH female to G3/8" LH male Swirvel angled 45 degree	Brass		A900-043



Description	Material	Factory	IGT DK
		Item No.	Item No.
G1/4" LH male angled 90 degree to G1/4" LH female brass	Brass	QJCP000137	A900-141



Description	Material	Factory	IGT DK
		Item No.	Item No.
8mm nozzle angled 90 degree to G1/4" LH female brass	Brass	QJCP000159	A900-163



Description	Material	Factory	IGT DK
		Item No.	Item No.
5/8" UNF female to 8mm nozzle Brass	Brass	QJCP000183	A900-213



Description	Material	Factory	IGT DK
		Item No.	Item No.
G1/4 LH 90° to 6.3mm	Brass	QJCP000207	A900-168

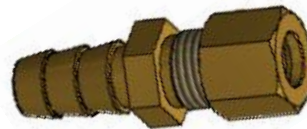

Description	Material	Factory	IGT DK
		Item No.	Item No.
G3/8" Compression to 10mm nozzle Brass	Brass	QJCP000126	A900-130

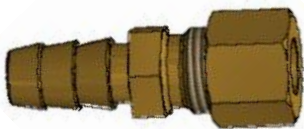

Description	Material	Factory	IGT DK
		Item No.	Item No.
10mm compression to 10mm nozzle	Brass	QJCP000133	A900-137

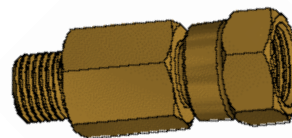

Description	Material	Factory	IGT DK
		Item No.	Item No.
5/8" UNF female to G1/4 LH male long body	Brass	QJCP000232	A900-244

- G3/8" LH connections are used with high pressure gas equipment
- G1/4" LH connections are used with low pressure gas equipment

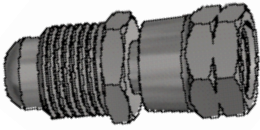

Description	Material	Factory	IGT DK
		Item No.	Item No.
5/8" UNF male to G1/4 LH female	Steel	QJCP000099	A900-106
5/8" UNF-18 male G 1/4"-LH nut	Brass	QJCP000098	A900-201

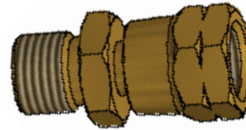

Description	Material	Factory	IGT DK
		Item No.	Item No.
G1/4 LH male to G1/4 RH female	Brass	QJCP000160	A900-039

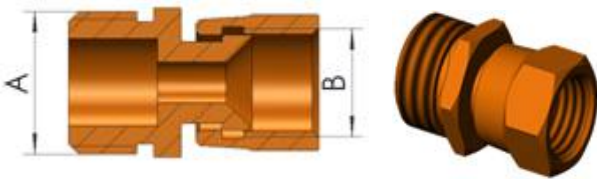

Description	Material	Factory	IGT DK
		Item No.	Item No.
G1/2" BSP male to 5/8" UNF female	Brass	QJCP000023	A900-110
G1/2" BSP male to G1/4" LH	Brass	QJCP000042	A900-093
G1/2" BSP male to G1/4" LH	Steel	QJCP000055	A900-105
G1/4" LH to 5/8" UNF female	Steel	QJCP000164	A900-165

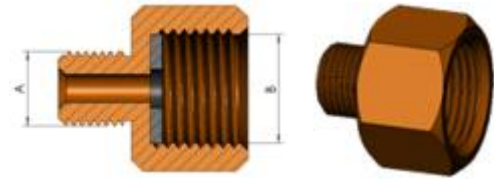

Description	Material	Factory	IGT DK
		Item No.	Item No.
G1/4" male to G1/2" female	Brass	QJCP000068	A900-103
G1/4" male to 5/8" UNF female	Brass	QJCP000096	A900-209
G1/4" male to G2 female	Brass	QJCP000095	A900-197

- Hose adaptors are used to bridge between different thread sizes and between US and EN standards.
- They also allow angled connections where narrow space is a challenge or if you want to connect to a steel or copper pipe.

HOSE EXTENSION PIECES

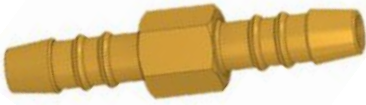

Description	Material	Factory	IGT DK
		Item No.	Item No.
6.3mm Hoze Nozzle both ends	Brass		A900-156



Description	Material	Factory	IGT DK
		Item No.	Item No.
8mm Hoze Nozzle both ends	Brass	QJCP000227	A900-160



Description	Material	Factory	IGT DK
		Item No.	Item No.
10mm Hoze Nozzle both ends	Brass	QJCP000159	A900-157



Description	Material	Factory	IGT DK
		Item No.	Item No.
G1/4" LH Nut to G1/4" LH male both sides	Steel	QJCP0001082	A900-082

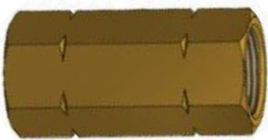

Description	Material	Factory	IGT DK
		Item No.	Item No.
2POL G10 female	Brass	QJCP000207	A900-121

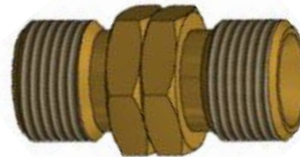

Description	Material	Factory	IGT DK
		Item No.	Item No.
G3/8" LH male both ends	Brass	QJCP000123	A900-123

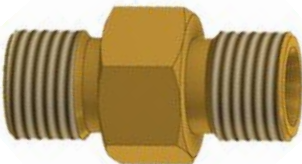

Description	Material	Factory	IGT DK
		Item No.	Item No.
G1/4" LH male both ends	Brass	QJCP000133	A900-176

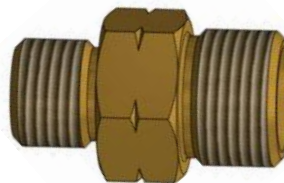

Description	Material	Factory	IGT DK
		Item No.	Item No.
G1/4" LH male to G3/8" LH male	Brass	QJCP000248	A900-044

HOSE EXTENSION PIECES

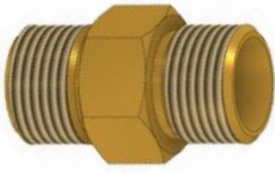

Description	Material	Factory	IGT DK
		Item No.	Item No.
G3/4" male both ends	Brass	QJCP000232	A900-177

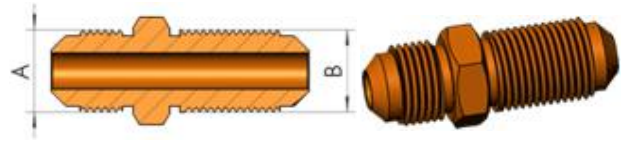

Description	Material	Factory	IGT DK
		Item No.	Item No.
5/8" UNF-5/8" UNF	Brass	Qj00000088	A900-202



Description	Material	Factory	IGT DK
		Item No.	Item No.
ID 8 mm hose nozzle	Brass	QJCP000049	A900-100
ID 10 mm hose nozzle	Brass	QJCP000114	A900-049
ID 11 mm hose nozzle	Brass	QJCP000115	A900-045



Description	Material	Factory	IGT DK
		Item No.	Item No.
ID 6.3 mm hose nozzle	Brass	FST0000001	A900-036
ID 8 mm hose nozzle	Brass	QJCP000174	A900-047
ID 10 mm hose nozzle	Brass	QJCP000182	A900-046

- Hose extension pieces allow you to extend or add additional hose length to your installation.
- Note. For hose length exceeding 1.5M, local government regulations may be applicable. A Long hose contain a lot of Gas. Gas safety must be considered - volume - bending - gas leak risk - pressure drop - recondensation - excess pressure build up etc to mention the most common issues.

PIPE TO HOSE ADAPTERS

D



Description	Material	Factory	IGT DK
		Item No.	Item No.
Adapter G3/8"RH male to 3/8"NPT	Brass	QJCP000134	A900-138

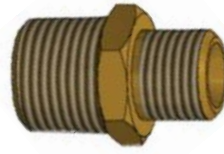

Description	Material	Factory	IGT DK
		Item No.	Item No.
3/8" NPT male to G1/4" RH male	Brass	QJCP000073	A900-112

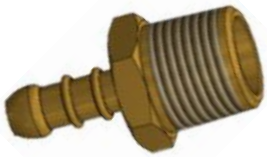

Description	Material	Factory	IGT DK
		Item No.	Item No.
8mm nozzle R1/2" male ISO7/1	Brass	QJCP000127	A900-131

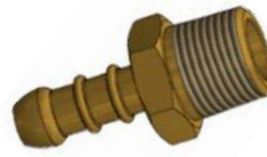

Description	Material	Factory	IGT DK
		Item No.	Item No.
8mm nozzle R3/8 male ISO 7/1	Brass	QJCP000128	A900-132



Description	Material	Factory	IGT DK
		Item No.	Item No.
8 mm nozzle -R1/4" male ISO 7/1	Brass	QJCP000129	A900-133



Description	Material	Factory	IGT DK
		Item No.	Item No.
11 mm nozzle -M14*1.5 male En8434	Brass	QJCP000185	A900-214



Description	Material	Factory	IGT DK
		Item No.	Item No.
11 mm nozzle - M16*1.5 male En8434	Brass	QJCP000186	A900-215



Description	Material	Factory	IGT DK
		Item No.	Item No.
11 mm nozzle - G1/4RH female	Brass	QJCP000187	A900-216

PIPE TO HOSE ADAPTERS

D



Description	Material	Factory	IGT DK
		Item No.	Item No.
R1/4 to 10mm nozzle	Brass	QJCP000205	A900-233



Description	Material	Factory	IGT DK
		Item No.	Item No.
G3/8 to 10mm nozzle	Brass	QJCP000206	A900-234



Description	Material	Factory	IGT DK
		Item No.	Item No.
3/8"NPT to 10mm nozzle	Brass	QJCP000007	A900-054



Description	Material	Factory	IGT DK
		Item No.	Item No.
1/2"NPT to 10mm nozzle	Brass	QJCP000008	A900-055

- The pipe to hose adapter allow you to bridge the connection between a steel pipe and a gas hose.

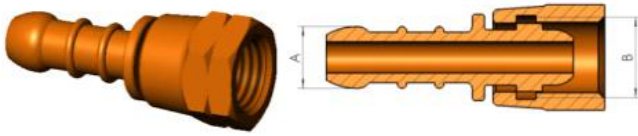

Description	Material	Factory	IGT DK
		Item No.	Item No.
ID 6,3 mm hose nozzle G 1/4"-LH nut	Brass	QJCP000096	A900-113
ID 8 mm hose nozzle G 1/4"-LH nut	Steel	QJCP000018	A900-073
ID 8 mm hose nozzle G 1/4"-LH nut	Brass	QJCP000184	A900-074
ID 9 mm hose nozzle G 1/4"-LH nut	Steel	QJCP000059	A900-109
ID 10 mm hose nozzle G 1/4"-LH nut	Steel	QJCP000019	A900-084
ID 11 mm hose nozzle G 1/4"-LH nut	Brass	QJCP000010	A900-060

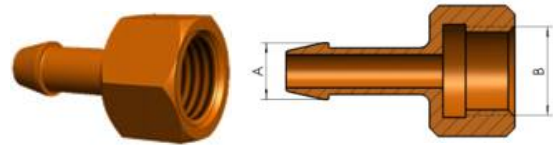

Description	Material	Factory	IGT DK
		Item No.	Item No.
ID 8 mm hose nozzle G2	Brass	QJCP000105	A900-198
ID 8,0 mm hose nozzle M20x1,5	Brass	QJCP000106	A900-116
ID 10 mm hose nozzle M20x1,5 LH nut	Brass	QJCP000107	A900-117
ID 8 mm hose nozzle G1/2" RH	Brass	QJCP000108	A900-088
ID 10 mm hose nozzle G1/2" RH	Brass	QJCP000109	A900-087
ID 8- 11 mm hose nozzle G3/8" RH	Brass	QJCP000110	A900-076

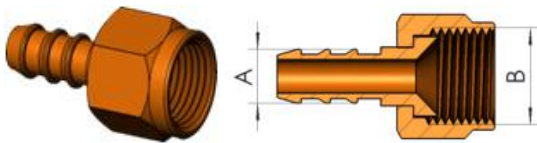

Description	Material	Factory	IGT DK
		Item No.	Item No.
ID 6,3 mm hose nozzle 5/8" UNF nut	Steel, Galvanization	QJCP000111	A900-118
ID 8 mm hose nozzle 5/8" UNF nut	Brass	QJCP000112	A900-200
ID 10 mm hose nozzle 5/8" UNF nut	Brass	QJCP000113	A900-193
ID 10 mm hose nozzle 5/8" UNF nut - Norwegian	Brass		A900-099

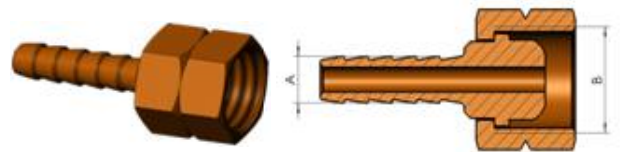

Description	Material	Factory	IGT DK
		Item No.	Item No.
ID 6,3mm hose nozzle G 3/8"-LH nut	Steel, Galvanization	QJCP000100	A900-114
ID 8 mm hose nozzle G 3/8"-LH nut	Brass	QJCP000101	A900-115
ID 9 mm hose nozzle G 3/8"-LH nut	Brass	QJCP000102	A900-196
ID 10 mm hose nozzle G 3/8"-LH nut	Brass	QJCP000104	A900-075

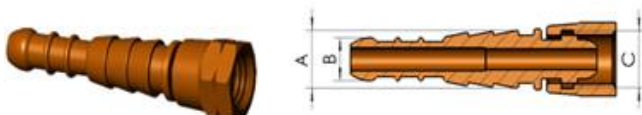

Description	Material	Factory	IGT DK
		Item No.	Item No.
ID 8-11 mm hose nozzle G1/4" LH nut	Steel, Galvanization	Qj00000028	A900-080
ID 8 -11mm hose nozzle 5/8" UNF -18	Brass	Qj00000091	A900-207
ID 8 -11mm hose nozzle G1/2" RH	Brass	QJCP000093	A900-083



Description	Material	Factory	IGT DK
		Item No.	Item No.
M20x1.5 female - 8 mm nozzle	Brass	QJCP000161	A900-164



Description	Material	Factory	IGT DK
		Item No.	Item No.
M20x1.5 female - 10 mm nozzle	Brass	QJCP000158	A900-162



Description	Material	Factory	IGT DK
		Item No.	Item No.
"Sheriff star" G6 inlet - R1/4" RH	Brass		A900-181



Description	Material	Factory	IGT DK
		Item No.	Item No.
"Sheriff star" G6 inlet - 1/4" NPT with auto excess flow 4 l/min	Brass		A900-182



Description	Material	Factory	IGT DK
		Item No.	Item No.
"Sheriff star" G6 inlet - 1/4" NPT with auto excess flow 8 l/min	Brass		A900-183



Description	Material	Factory	IGT DK
		Item No.	Item No.
"Sheriff star" G6 inlet - 6.3 mm nozzle	Brass		A900-180
"Sheriff star" G2 female - 6.3mm nozzle	Brass		A900-119

- Hoses used for Low pressure in EU is typical 6.3 - 8 - 10mm ID.
For gas appliances use EN16436-1 For gas torches use ISO 3821 Hoses.
- EN16436-2 define a hose assembly. Typically a hose with a fitting both ends.
Attached by a compressed sleeve or a hose clamp. Note EN16436-2 has strict regulations on testing and marking of such products- as well as certifications in many markets i.e. DVGW.

- IGT gas filters 99,9 % of the aerosols from the gas and protects the LPG installation down stream. Filter unit can be exchanged – recommended every 2 years or whenever it is needed. Depending on the gas quality.

Technical data:

Gas type : LPG - Propane Butane Pressure : 0,3 -16 bar

Filter inlet/ Outlet :

8 mm Compression fitting - 10 mm compression fitting
M20 x 1,5 W21,8-G12

Dimensions :

Compression fitting to EN1254. L x W x D 115 x 54 x 74 mm.

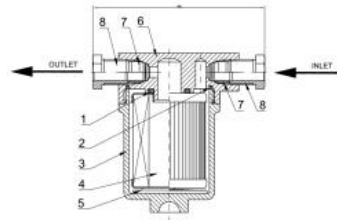

Description	Material	Factory Item No.	IGT DK Item No.
8mm compression both ends	Zinc & Brass	QJCP000201	A900-F001

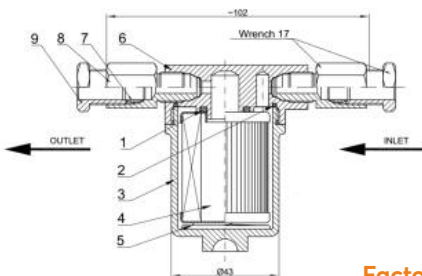

Description	Material	Factory Item No.	IGT DK Item No.
10mm compression both ends	Zinc & Brass	QJCP000202	A900-F002

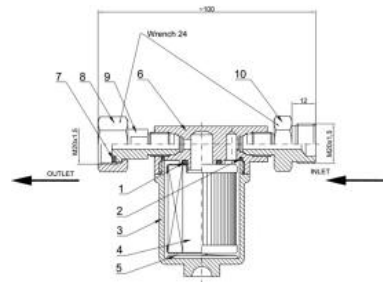

Description	Material	Factory Item No.	IGT DK Item No.
M20x1.5 + M20x1.5	Zinc & Brass	QJCP000203	A900-F004

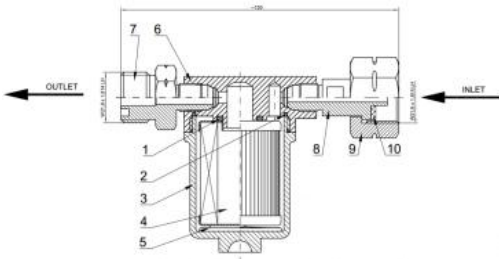

Description	Material	Factory Item No.	IGT DK Item No.
W21.8*1.814 + W21.8*1.814	Zinc & Brass	QJCP000204	A900-F005

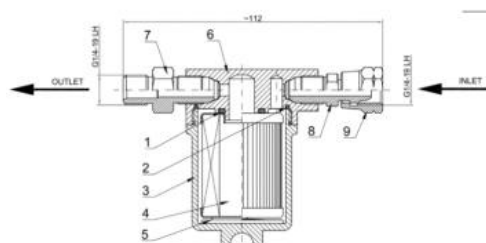

Description	Material	Factory Item No.	IGT DK Item No.
G1/4-19LH / G1/4-19LH Filter	Zinc & Brass	QJCP000208	A900-F003



Description	Material	Factory Item No.	IGT DK Item No.
Replacement filter unit	Steel Rubber		A900-F999.



Description	Material	Factory Item No.	IGT DK Item No.
Bracket for wall	Steel		A900-F993

REDUCTION ADAPTORS



Description	Material	Factory	IGT DK
		Item No.	Item No.
G1/4" LH female to G3/8" LH male	Brass		A900-262



Description	Material	Factory	IGT DK
		Item No.	Item No.
G3/8LH female to G1/4LH male	Brass	QJCP000118	A900-122

- Allow you to bridge from one thread size to another.



Description	Material	Factory	IGT DK
		Item No.	Item No.
G1/2RH to G3/8RH	Brass	Y400LJ0056	A900-052

POL ADAPTORS



Description	Material	Factory	IGT DK
		Item No.	Item No.
POL CGA 510 (G10) male - 2x POL female out LONG = 123 mm	Brass		A900-185



Description	Material	Factory	IGT DK
		Item No.	Item No.
POL CGA 510 (G10) male - 2x POL female out Short = 47 mm	Brass		A900-184



Description	Material	Factory	IGT DK
		Item No.	Item No.
POL male to G7 female	Brass	QJCP000166	A900-167

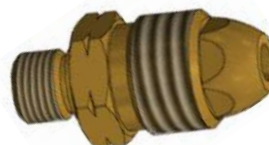

Description	Material	Factory	IGT DK
		Item No.	Item No.
POL to G1/4 LH male	Brass	QJCP000120	A900-124

POL ADAPTORS



Description	Material	Factory	IGT DK
		Item No.	Item No.
POL 6,3-8 mm nozzle wing nut	Brass	QJCP000121	A900-125



Description	Material	Factory	IGT DK
		Item No.	Item No.
POL - 8 mm nozzle	Brass	QJCP000122	A900-126

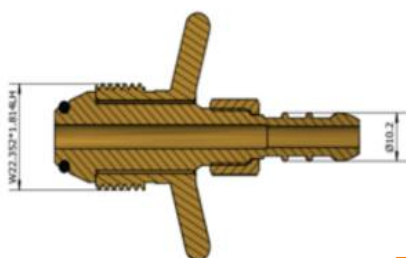

Description	Material	Factory	IGT DK
		Item No.	Item No.
POL to 8mm nozzle	Brass	QJCP000242	A900-101

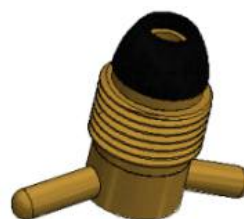

Description	Material	Factory	IGT DK
		Item No.	Item No.
POL female G1-4 inch BSP +G10	Brass	QJCP000123	A900-127



Description	Material	Factory	IGT DK
		Item No.	Item No.
POL to 8-6,3 mm nozzle with internal excess flow + G1/4 filter gasket	Brass	QJCP000125	A900-129



Description	Material	Factory	IGT DK
		Item No.	Item No.
POL Olive gasket	NBR		A300-999

PLUGS

J



Description	Material	Factory	IGT DK
		Item No.	Item No.
Compression fitting plug 8 mm	Brass		A900-022



Description	Material	Factory	IGT DK
		Item No.	Item No.
Compression fitting plug 10 mm	Brass		A900-028



Description	Material	Factory	IGT DK
		Item No.	Item No.
Compression fitting plug 3/8"	Brass		A900-025



Description	Material	Factory	IGT DK
		Item No.	Item No.
POL plug G10	Brass	QJCP000124	A900-128

NUT AND NIPPLE PARTS



Description	Material	Factory	IGT DK
		Item No.	Item No.
Compression fitting cutting ring 8 mm	Steel		A900-291



Description	Material	Factory	IGT DK
		Item No.	Item No.
Compression fitting cutting ring 10 mm	Steel		A900-292



Description	Material	Factory	IGT DK
		Item No.	Item No.
Compression fitting cutting ring 3/8"	Steel		A900-294



Description	Material	Factory	IGT DK
		Item No.	Item No.
Compression fitting nut 8 mm	Steel		A900-289



Description	Material	Factory	IGT DK
		Item No.	Item No.
Compression fitting nut 10 mm	Steel		A900-290



Description	Material	Factory	IGT DK
		Item No.	Item No.
Compression fitting nut 3/8"	Steel		A900-295



Description	Material	Factory	IGT DK
		Item No.	Item No.
Compression fitting nut 8 mm	Brass		A900-020



Description	Material	Factory	IGT DK
		Item No.	Item No.
Compression fitting nut 10 mm	Brass		A900-026

NUT AND NIPPLE PARTS



Description	Material	Factory	IGT DK
		Item No.	Item No.
Compression fitting nut G3/8"	Brass		A900-023



Description	Material	Factory	IGT DK
		Item No.	Item No.
Compression fitting cutting ring 8 mm	Brass		A900-021



Description	Material	Factory	IGT DK
		Item No.	Item No.
Compression fitting cutting ring 10 mm	Brass		A900-027



Description	Material	Factory	IGT DK
		Item No.	Item No.
Compression fitting cutting ring G3/8"	Brass		A900-024



Description	Material	Factory	IGT DK
		Item No.	Item No.
8 mm nipple for G1/4" LH nut	Brass	FXZ0000108	A900-037

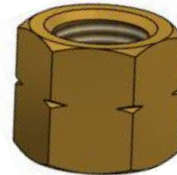

Description	Material	Factory	IGT DK
		Item No.	Item No.
Nut G1/4" LH	Brass	FLM0000025	A900-038

- Brass cutting ring + nut are used with copper tubing.
Steel cutting ring + nut are used with steel tubing.
Stainless Steel versions are available!
- Note: Always use brass sleeves inside copper tubing to avoid unwanted deformation of the copper pipe.

SLEEVES AND CLAMPS

L

- The brass sleeves are placed inside the 8 or 10 mm copper tubing before it is connected to a compression fitting. When the compression nut is tightened the sleeve ensure the soft copper tubing is not deformed and a gas tight connection is established.



Description	Material	Factory	IGT DK
		Item No.	Item No.
Sleeve 3/8 "	Brass		A900-186



Description	Material	Factory	IGT DK
		Item No.	Item No.
Sleeve 10 mm	Brass		A900-187



Description	Material	Factory	IGT DK
		Item No.	Item No.
Sleeve 8 mm	Brass		A900-166

COMPRESSION FITTING ADAPTORS

M

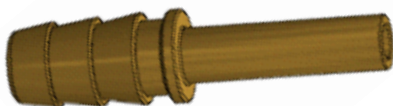

Description	Material	Factory	IGT DK
		Item No.	Item No.
10 mm nozzle - 8 mm tube	Brass	QJCP000132	A900-136

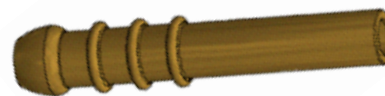

Description	Material	Factory	IGT DK
		Item No.	Item No.
8 mm nozzle - 8 mm tube	Brass	QJCP000130	A900-134
6.3 mm nozzle - 8 mm tube	Brass	QJCP000130	A900-203
8 mm nozzle - 3/8" tube	Brass	QJCP000130	A900-267

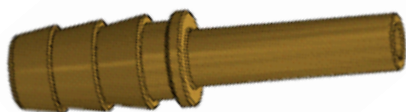

Description	Material	Factory	IGT DK
		Item No.	Item No.
10 mm nozzle - 3/8"mm tube	Brass	QJCP000184	A900-212

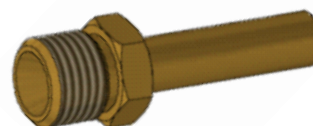

Description	Material	Factory	IGT DK
		Item No.	Item No.
G1/4LH male to 8mm tube	Brass	QJCP000216	A900-222

COMPRESSION FITTING ADAPTORS



Description	Material	Factory	IGT DK
		Item No.	Item No.
10mm nozzle-8mm Compression fitting with wall bracket	Brass	QJCP000139	A900-143

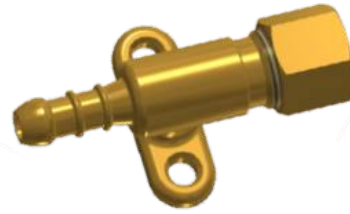

Description	Material	Factory	IGT DK
		Item No.	Item No.
8 mm nozzle-3/8" Compression fitting with wall bracket	Brass	QJCP000140	A900-144



Description	Material	Factory	IGT DK
		Item No.	Item No.
8mm nozzle-8mm Compression fitting with wall bracket	Brass	QJCP000138	A900-142



Description	Material	Factory	IGT DK
		Item No.	Item No.
10 mm nozzle-8 mm compression fitting	Brass	QJCP000135	A900-139

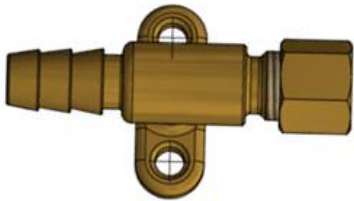

Description	Material	Factory	IGT DK
		Item No.	Item No.
10mm nozzle to 3/8" compression fitting	Brass	QJCP000167	A900-171



Description	Material	Factory	IGT DK
		Item No.	Item No.
6,3 mm nozzle-10 mm compression fitting	Brass	QJCP000165	A900-205



Description	Material	Factory	IGT DK
		Item No.	Item No.
8 mm nozzle-8 mm compression fitting	Brass	QJCP000136	A900-140



Description	Material	Factory	IGT DK
		Item No.	Item No.
compression fitting 10mm female M20 x 1.5	Brass		A900-011
compression fitting 10mm male M20 x 1.5	Brass		A900-012

COMPRESSION FITTING ADAPTORS



Description	Material	Factory	IGT DK
		Item No.	Item No.
3/8" Compression fitting to 5/8" UNF male	Brass	QJCP000157	A900-161



Description	Material	Factory	IGT DK
		Item No.	Item No.
10 mm Compression fitting - 8 mm tube	Brass		A900-204



Description	Material	Factory	IGT DK
		Item No.	Item No.
3/8" Compression fitting to G1/2 RH male	Brass	QJCP000103	A900-102



Description	Material	Factory	IGT DK
		Item No.	Item No.
3/8" Compression fitting to G3/8 RH male Brass	Brass	QJCP000181	A900-098

- The compression fitting bridges the connection between the hose and pipe.
- Typically used for installation when you want to place the gas cylinder outside or in a ventilated compartment.
- In Europe such installations must comply to EN1949. DVGW ARBEITSBLATT G607. Explains well the installation procedures.

COMPRESSION FITTING ADAPTORS



Description	Material	Factory	IGT DK
		Item No.	Item No.
8mm compression fitting to G1/4LH male	Brass	QJCP000188	A900-217



Description	Material	Factory	IGT DK
		Item No.	Item No.
G1/4LH female to G3/8" Compression fitting	Brass	QJCP000213	A900-235



Description	Material	Factory	IGT DK
		Item No.	Item No.
G1/4-19LH female to 8mm compression fitting	Brass	QJCP000214	A900-236



Description	Material	Factory	IGT DK
		Item No.	Item No.
G1/4LH female to 10mm compression fitting	Brass	QJCP000215	A900-237



Description	Material	Factory	IGT DK
		Item No.	Item No.
8 mm compression fitting Bulkhead - 8 mm nozzle	Brass		A900-081

N



TOOLS

Description	Material	Factory	IGT DK
		Item No.	Item No.
Spanner 17mm to 19mm	08F	Y100BS0001	A900-001

P



PIPE TO PIPE ADAPTORS

Description	Material	Factory	IGT DK
		Item No.	Item No.
1/4" NPT to 1/4" NPT	Brass	QJCP000116	A900-120



Description	Material	IGT DK	
		Item No.	
Quick coupling with push button release 6.3mm hose nozzle both sides. PN 16bar	Steel	A900-299	



Description	Material	Factory	IGT DK
		Item No.	Item No.
Male	Steel		A900-300



Description	Material	Factory	IGT DK
		Item No.	Item No.
G3/8" LH Quick Male PN 16 bar	Brass		A900-301
3/8" Male Quick Female	Brass		A900-310
3/8" Female Nut Quick male	Brass		A900-311

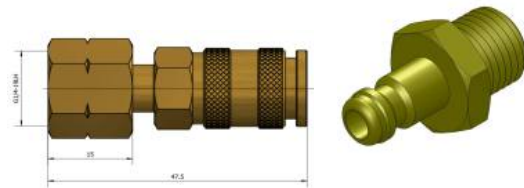

Description	Material	Factory	IGT DK
		Item No.	Item No.
G1/4LH female to G1/4LH male Quick connector	Brass	QJCP000309	A900-264
G1/4" LH to Quick Female	Brass		A900-247
G1/4" LH to Quick Male	Brass		A900-248

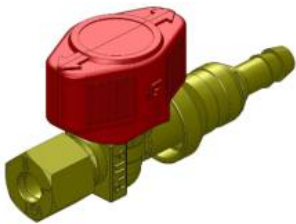

Description	Material	Factory	IGT DK
		Item No.	Item No.
8mm compression to Quick Acting Valve - 8mm nozzle	Brass		A900- 226
10mm compression to Quick Acting Valve - 10mm nozzle	Brass		A900- 238



Description	Material	Factory	IGT DK
		Item No.	Item No.
8mm compression fitting to Quick Coupling - 8mm tube	Brass		A900-239
8mm compression fitting to Quick Coupling - 8mm nozzle	Brass		A900-225



Description	Material	Factory	IGT DK
		Item No.	Item No.
8mm compression to Quick Acting Valve 3 way 8mm tube	Brass		A900-240
8mm compression to Quick Acting Valve 3 way 8mm nozzle	Brass		A900-227



Description	Material	Factory	IGT DK
		Item No.	Item No.
G3/8" LH female - Quick coupling	Brass		A900-241
G1/4" LH male - 3/8" tube	Brass		A900-266

QUICK COUPLING

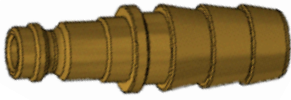

Description	Material	Factory	IGT DK
		Item No.	Item No.
10mm hosenozzle to quick connector male	Brass		A900-246
8mm hosenozzle to quick connector male	Brass		A900-297
8mm tube to quick connector male	Brass		A900-298



Description	Material	Factory	IGT DK
		Item No.	Item No.
G1/4" LH male to 8mm nozzle female quick coupling	Brass		A900-218



Description	Material	Factory	IGT DK
		Item No.	Item No.
G1/4" LH male to 6.3mm female quick coupling	Brass		A900-219



Description	Material	Factory	IGT DK
		Item No.	Item No.
Compression fitting nut 8 mm	Brass		A900-223



Description	Material	Factory	IGT DK
		Item No.	Item No.
8-8mm nozzle quick coupling	Brass		A900- 224
10-10mm nozzle quick coupling	Brass		A900- 040



Description	Material	Factory	IGT DK
		Item No.	Item No.
G1/4" LH with male to 10mm nozzle female quick coupling	Brass		A900-245



Description	Material	Factory	IGT DK
		Item No.	Item No.
G1/4" LH nut male to 10mm nozzle female quick coupling	Brass		A900-256



Description	Material	Factory	IGT DK
		Item No.	Item No.
G1/4" LH male to 8mm nozzle female quick coupling	Brass		A900-257
Quick coupling male to 8mm nozzle Angled 45°	Brass		A900-307

VALVE (HP EXCESS FLOW VALVES)

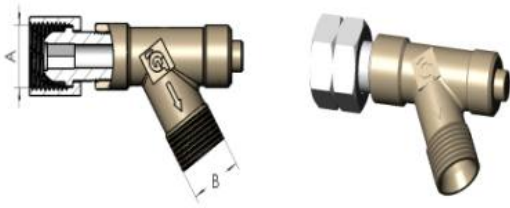

A	B	Pressure range	Gas type	Material	Flow rate	Factory Item No.	IGT DK Item No.
G3/8"-LH nut	G3/8"-male	1.5-4 bar	LPG	Zinc	6-8.5kg/h	A910ZJ3001	A910-001

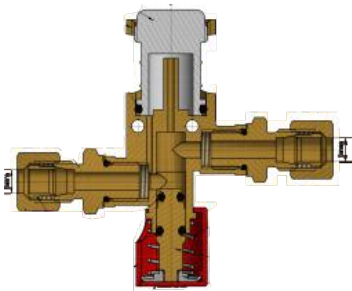

A	B	Pressure range	Gas type	Factory Item No.	IGT DK Item No.
			LPG	QJCP000330	A900-002



A	B	Pressure range	Gas type	Factory Item No.	IGT DK Item No.
G1 female	G3/8-19LH male	0-16bar	LPG		A910-004



A	B	Pressure range	Gas type	Factory Item No.	IGT DK Item No.
G2 female	G3/8-19LH male	0-16bar	LPG		A910-005

VALVE (HP EXCESS FLOW VALVES)



A	B	Pressure range	Gas type	Factory Item No.	IGT DK Item No.
G5 female	G3/8-19LH male	0-16bar	LPG		A910-006



A	B	Pressure range	IGT DK Item No.
G7 male	G3/8-19LH male	0-16bar	A910-007



A	B	Pressure range	IGT DK Item No.
G8 female	G3/8-19LH male	0-16bar	A910-008



A	B	Pressure range	IGT DK Item No.
G10 male	G3/8-19LH male	0-16bar	A910-009



A	B	Pressure range	IGT DK Item No.
G12 female	G3/8-19LH male	0-16bar	A910-010

- HP EXV are used directly after the gas cylinder valve.
Or connected to the outlet of a HP regulator

GAS LEAK TESTER

- The gas leak tester is used for mobile homes, leisure housing, caravan and boats where you have a combination of LPG hose and 2-15 meter of copper piping ending with a hose connecting to a gas appliance.
- The leak tester monitor the gas tightness- a push on the red knob reveals any gas leaks down stream of the detector.



		Factory	IGT DK
Connections	Material	Item No.	Item No.
Glykol refill			A900-010

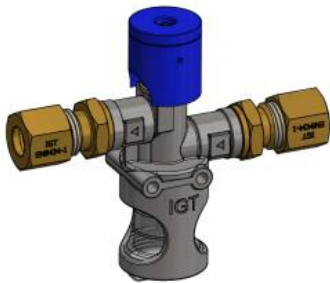

		Factory	IGT DK
Connections	Material	Item No.	Item No.
8 mm compression	Zinc & Brass		A900-002



		Factory	IGT DK
Connections	Material	Item No.	Item No.
10 mm compression	Zinc & Brass		A900-004



		Factory	IGT DK
Connections	Material	Item No.	Item No.
8 mm hose nozzle	Zinc & Brass		A900-005



		Factory	IGT DK
Connections	Material	Item No.	Item No.
10 mm hose nozzle	Zinc & Brass		A900-006

- Manual change over valves are used to service one gas cylinder while the other cylinder is stand by.
- More cylinders on each side of the valve can be connected by use of a manifold.



A	B	Gas type	Working Pressure	Factory Item No.	IGT DK Item No.
7/16" BSP	1/4" NPT	LPG	20 bar		A900-V009



A	B	Gas type	Working Pressure	Factory Item No.	IGT DK Item No.
8 mm compression fitting	8 mm compression fitting	LPG	25 bar		A900-V004



A	B	Gas type	Working Pressure	IGT DK Item No.
10 mm compression fitting	10 mm compression fitting	LPG	25 bar	A900-V005

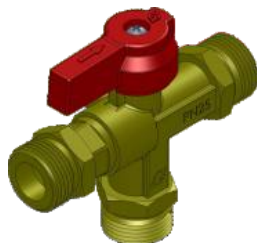

A	B	Gas type	Working Pressure	IGT DK Item No.
G4-W21,8	G4-W21,8	LPG	25 bar	A900-V006
M20x1,5	M20x1,5	LPG	25 bar	A900-V007

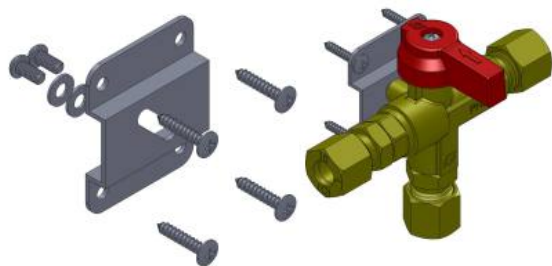

- Wall Bracket IGT DK Item No. A900-V999

VALVE (CHANGE OVER VALVE)



A	B	Gas type	Working Pressure	Factory Item No.	IGT DK Item No.
Angle outlet M20x1,5	M20x1,5	LPG	1.5-4 bar		A900-296
M20x1,5 MaleFold	M20x1,5	LPG	1.5-4 bar		A900-265

- Manual change over Pigtails designed for A900-V006 and A900-V007. Twist and tension free. Length 300mm or 400mm

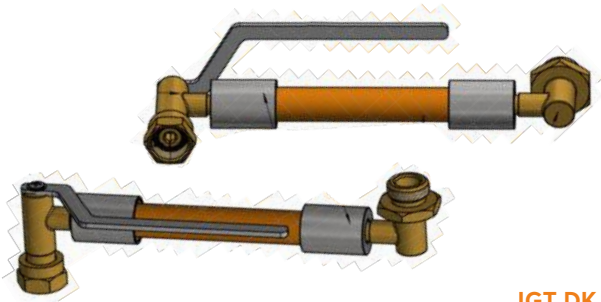

IGT DK

Hose dims.	Hose dims.	Type	Item No.
M20x1,5	G2-W21,8 Male	LPG	S006-HP301

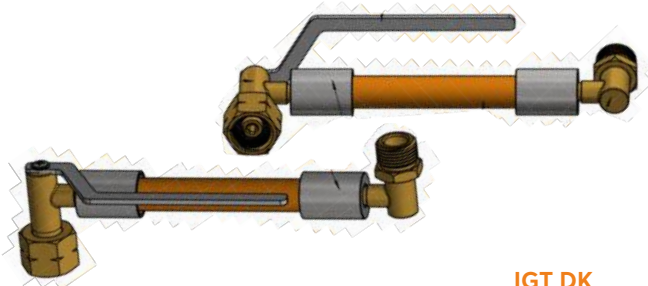

IGT DK

Hose dims.	Hose dims.	Type	Item No.
G4 W21,8	G4-W21,8 Male	LPG	S006-HP300

- Other inlet/outlet connections can be supplied.

BALL VALVE WITH M5 TEST POINT

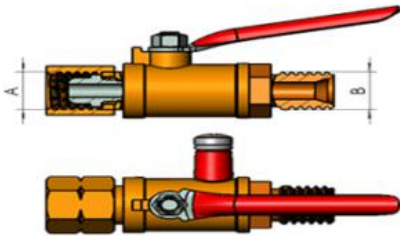

A	B	Working pressure	Gas type	Test point connection	Material	Factory	IGT DK
						Item No.	Item No.
G 1/4" nut	G 1/4" female	20 bar	LPG	NO	Brass	QJCP000078	A900-V001
G 1/4" nut	G 1/4" female	20 bar	LPG	YES	Brass	QJCP000078	A900-V002

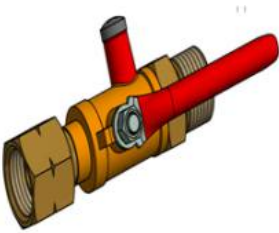

A	B	Working pressure	Gas type	Test point connection	Material	Factory	IGT DK
						Item No.	Item No.
G 3/8" nut	G 3/8" female	20 bar	LPG	YES	Brass	QJCP000079	A900-V003



A	B	Working pressure	Gas type	Test point connection	Material	Factory	IGT DK
						Item No.	Item No.
5/8" UNF nut	5/8" UNF female	20 bar	LPG	YES	Brass		A900-V008

- The test point ball valve is used just after the LP regulator in Caravan, Boat and Leisure house installations. The test point is used to conduct the EN1949-150mbar gas leak test. Mandatory for EU markets.
- Ask for our test hose and test pump solutions.

VALVE (NEEDLE VALVE)



Description	Material	Working Pressure	Factory	IGT DK
			Item No.	Item No.
M16x1,5 inlet - W21,8 outlet angled 90 degree	Brass	20 bar		A900-104
M14x1,5 inlet - W21,8 outlet angled 90 degree	Brass	20 bar		A900-085
M14x1,5 inlet - G3/8" - LH outlet angled 90 degree	Brass	20 bar		A900-086
M16x1,5 inlet - G3/8" - LH outlet angled 90 degree	Brass	20 bar		A900-079



Description	Material	Working Pressure	Factory	IGT DK
			Item No.	Item No.
8 mm nozzle 3 way	Brass	0.5 bar		A900-V254



Description	Material	Working Pressure	Factory	IGT DK
			Item No.	Item No.
M14x1,5- G3/8" LH	Brass	20 bar		A900-V256

- Needle valves are used to adjust gas flows without reducing the gas pressure. (pressure drop over valve and pipe must be considered)

VALVE (NEEDLE VALVE)



Description	Material	Working Pressure	Factory	IGT DK
			Item No.	Item No.
90° Needle valve G1/4LH female to G1/4 LH male	Brass	4 bar	QJCP000212	A900-179

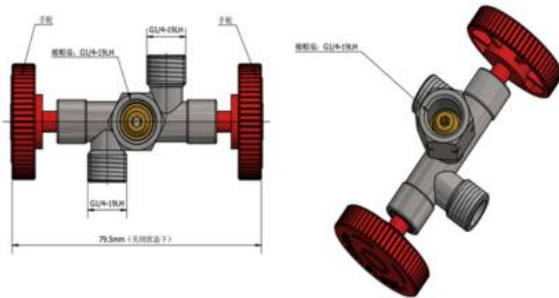

Description	Material	Working Pressure	Factory	IGT DK
			Item No.	Item No.
Double outlet valve	Zinc	4 bar	QJCP000211	A900-178



Description	Material	Working Pressure	Factory	IGT DK
			Item No.	Item No.
Needle with H50 both ends	Brass	20 bar	Y100LJ0034	A900-V250



Description	Material	Working Pressure	Factory	IGT DK
			Item No.	Item No.
Needle valve with 1/8"NPT female both ends Brass	Brass	20 bar	Y100LJ0036	A900-V251

VALVE (NEEDLE VALVE)

NV

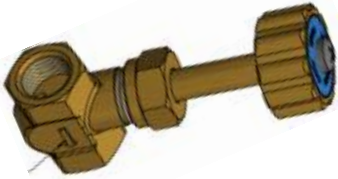

Description	Material	Working Pressure	Factory	IGT DK
			Item No.	Item No.
Needle valve with 1/4"NPT Female both ends Brass	Brass	20 bar	Y100LJ0029	A900-V252

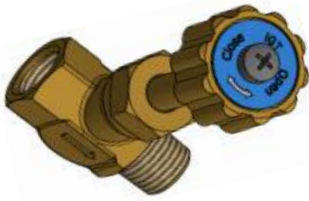

Description	Material	Working Pressure	Factory	IGT DK
			Item No.	Item No.
Needle valve with 1/4"NPT Female to 1/4"NPT male Brass	Brass	20 bar	Y100LJ0035	A900-V253

QUICK ACTING VALVES & COMPRESSION FITTINGS



Description	Material	Factory	IGT DK
		Item No.	Item No.
Union 8 mm compression fitting	Brass	QJCP000141	A900-145
Union 8-10 mm compression fitting	Brass		A900-249

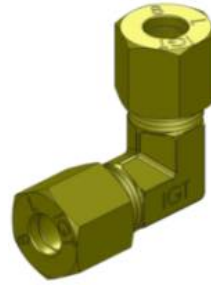

Description	Material	Factory	IGT DK
		Item No.	Item No.
Angle 90 degree compression fitting 8-8 mm	Brass	QJCP000142	A900-146



Description	Material	Factory	IGT DK
		Item No.	Item No.
T-Compression fitting 8 mm	Brass	QJCP000143	A900-147



Description	Material	Factory	IGT DK
		Item No.	Item No.
R3/8" ISO7/1- 8 mm compression fitting	Brass	QJCP000144	A900-148



Description	Material	Factory	IGT DK
		Item No.	Item No.
Union G3/8" compression fitting	Brass	QJCP000145	A900-149



Description	Material	Factory	IGT DK
		Item No.	Item No.
T-Union G3/8" compression fitting	Brass	QJCP000146	A900-150



Description	Material	Factory	IGT DK
		Item No.	Item No.
Angle 90 degree compression fitting 3-8"-3/8"	Brass	QJCP000147	A900-151



Description	Material	Factory	IGT DK
		Item No.	Item No.
Compression fitting 8mm straight Bulkhead EN8434	Brass	QJCP000209	A900-220
Compression fitting 10mm straight Bulkhead EN8434	Brass		A900-242

QUICK ACTING VALVES & COMPRESSION FITTINGS



Description	Material	Factory	IGT DK
		Item No.	Item No.
Compression fitting 3/8" straight bulkhead EN8434	Brass	QJCP000210	A900-221



Description	Material	Factory	IGT DK
		Item No.	Item No.
Compression fitting 8mm straight bulkhead EN8434	Steel		A900-305
Compression fitting 3/8" straight bulkhead EN8434	Steel		A900-303
Compression fitting 10mm straight bulkhead EN8434	Steel		A900-308

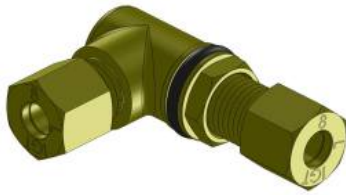

Description	Material	Factory	IGT DK
		Item No.	Item No.
Compression fitting 8 mm angled 90 degree Bulkhead	Brass		A900-169



Description	Material	Factory	IGT DK
		Item No.	Item No.
Compression fitting 8 mm angled 90 degree T unit	Brass		A900-304
Compression fitting 10 mm angled 90 degree T unit	Brass		A900-306
3/8"	Brass		A900-302



Description	Material	Factory	IGT DK
		Item No.	Item No.
Quick Acting Block valve (double o-ring sealing) with wall bracket- 8 mm compression fitting	Brass	QJCP000148	A900-152

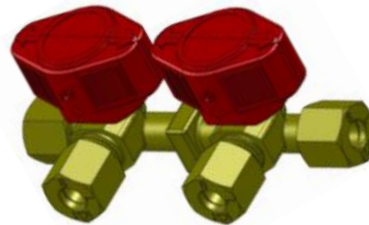

Description	Material	Factory	IGT DK
		Item No.	Item No.
Double Quick Acting Block valve (double o-ring sealing) with wall bracket-8mm compression fitting	Brass	QJCP000149	A900-153

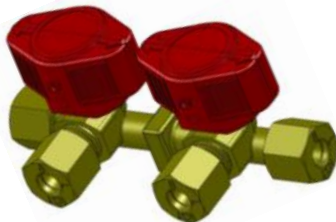

Description	Material	Factory	IGT DK
		Item No.	Item No.
Double Quick Acting Block valve (double o-ring sealing) with wall bracket- 10 mm compression fitting in 8mm out	Brass	QJCP000149	A900-250



Description	Material	Factory	IGT DK
		Item No.	Item No.
Quick Acting Block valve (double o-ring sealing) with wall bracket-3/8" compression fitting	Brass	QJCP000150	A900-230

QUICK ACTING VALVES & COMPRESSION FITTINGS



Description	Material	Factory	IGT DK
		Item No.	Item No.
Compression fitting 8mm Steel Union	Steel		A900-280
Compression fitting 8-10mm Steel Union	Steel		A900-281



Description	Material	Factory	IGT DK
		Item No.	Item No.
T - Compression fitting 8mm Steel Union	Steel		A900-282

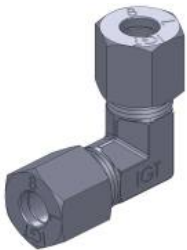

Description	Material	Factory	IGT DK
		Item No.	Item No.
90° Compression fitting 8mm Steel Union	Steel		A900-283



Description	Material	Factory	IGT DK
		Item No.	Item No.
90° Compression fitting 8-10mm Steel Union	Steel		A900-284



Description	Material	Factory	IGT DK
		Item No.	Item No.
Compression fitting 10mm Steel Union			A900-285



Description	Material	Factory	IGT DK
		Item No.	Item No.
T - Compression fitting 8-10mm Steel Union			A900-286



Description	Material	Factory	IGT DK
		Item No.	Item No.
T - Compression fitting 10mm Steel Union			A900-287

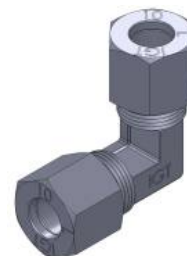

Description	Material	Factory	IGT DK
		Item No.	Item No.
90° Compression fitting 10mm Steel Union			A900-288

QUICK ACTING VALVES & COMPRESSION FITTINGS

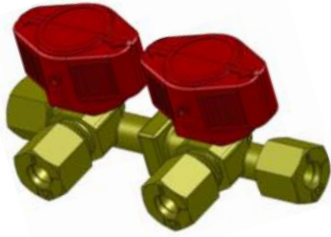

Description	Material	Factory	IGT DK
		Item No.	Item No.
Double Quick Acting Block valve (double o-ring sealing) 3/8" compression fitting	Brass	QJCP000151	A900-231

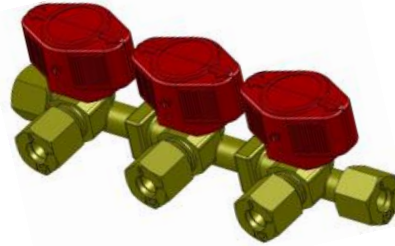

Description	Material	Factory	IGT DK
		Item No.	Item No.
Triple Quick Acting Block valve (double o-ring sealing) 8mm compression fitting	Brass	QJCP000152	A900-155

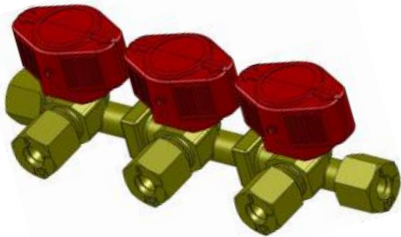

Description	Material	Factory	IGT DK
		Item No.	Item No.
Triple Quick Acting Block valve (double o-ring sealing) 3/8" compression fitting	Brass	QJCP000153	A900-232

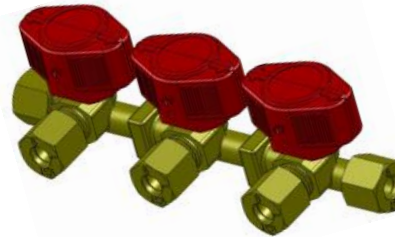

Description	Material	Factory	IGT DK
		Item No.	Item No.
Triple Quick Acting Block valve (double o-ring sealing) 10mm compression fitting in -8mm out	Brass	QJCP000152	A900-251



Description	Material	Factory	IGT DK
		Item No.	Item No.
10mm T- Quick acting gas valve with wall bracket	Brass	QJCP000176	A900-173
8mm T- Quick acting gas valve with wall bracket	Brass	QJCP000176	A900-154



Description	Material	Factory	IGT DK
		Item No.	Item No.
3/8" T- Quick acting gas valve with wall bracket	Brass	QJCP000177	A900-174

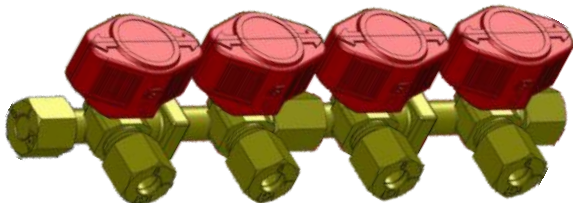

Description	Material	IGT DK
		Item No.
Quick acting gas valve (double o-ring sealing) 8mm in - out	Brass	A900-252
Quick acting gas valve (double o-ring sealing) 10mm in - 8mm out	Brass	A900-253

IGT DK

Item No.

A900-175



IGT DK

Item No.

A900-003

• Sticker

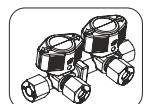

- Wall Bracket solutions as optional feature.
- Quick Acting Valves are used for Caravan, Boat and Leisure homes and professional cooking vehicles.

QUICK ACTING VALVES COMPRESSIONA



Description	Material	Factory	IGT DK
		Item No.	Item No.
Leak spray	Brass		H900-001

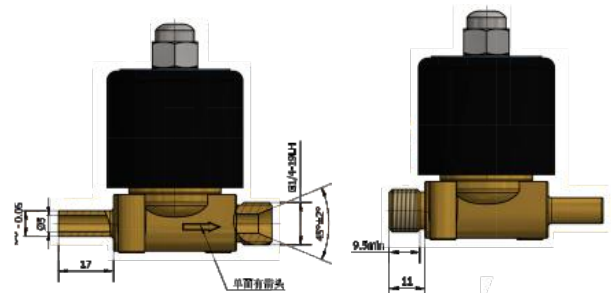

Description	Material	Factory	IGT DK
		Item No.	Item No.
In male G1/4" - LH - Out 8mm tube	Brass		H900-004



Description	Material	Factory	IGT DK
		Item No.	Item No.
Solenoid Valve G1/2"	Brass		H900-002

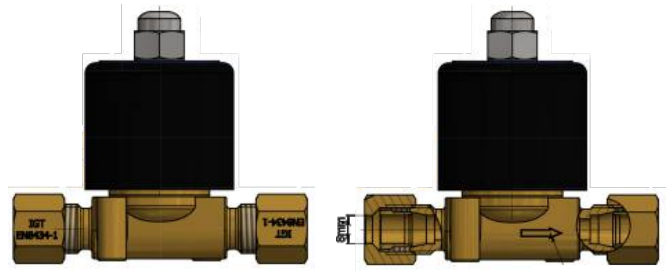

Description	Material	Factory	IGT DK
		Item No.	Item No.
In/Out 8mm compression fitting	Brass		H900-005



Description	Material	Factory	IGT DK
		Item No.	Item No.
Explosion proof solenoid valve G1/2"	Brass		H900-003

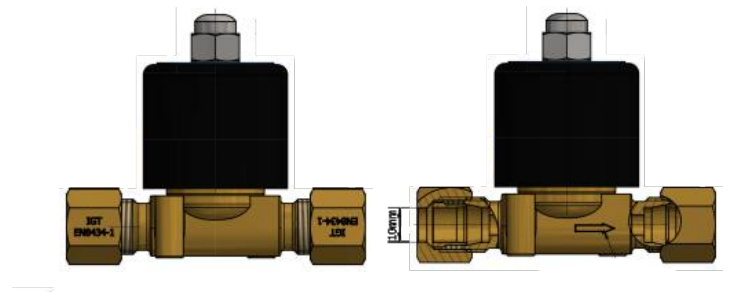

Description	Material	Factory	IGT DK
		Item No.	Item No.
In/Out 10mm compression fitting	Brass		H900-006

QUICK ACTING VALVES COMPRESSIONA

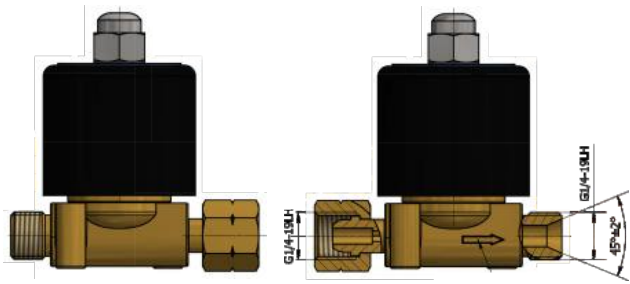

Description	Material	Factory	IGT DK
		Item No.	Item No.
In G1/4" LH Nut Out 1/4" LH male	Brass		H900-007

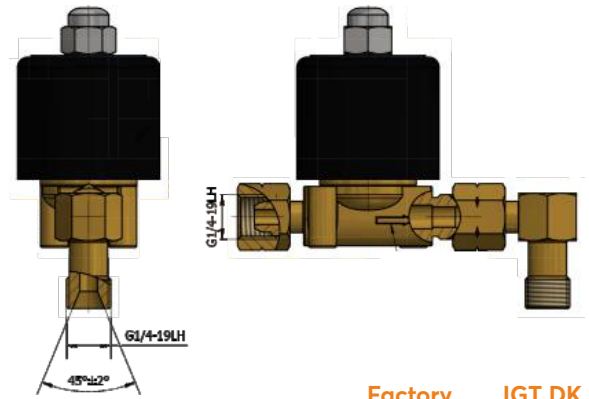

Description	Material	Factory	IGT DK
		Item No.	Item No.
In G1/4" LH Nut Out 90° 1/4" LH male rotating	Brass		H900-008

PVC HOSE - LOW PRESSURE ASSEMBLY (CLASS 2)

- To connect fittings, consuming appliances and piping
- Cold-resistant to -30°C
- Various hose standards can be offered. For EU EN16436-1 and EN16436-2 is predominantly used. Class 2.
- PVC hose is price competitive but has a short durability of less than 5 years. Recommended exchanged after 3 years or when ever it is due.
- Each IGT Hose assembly is tested 100% gas tight by compressed air at 20bar. Rubber hose is recommended due to the longer durability, and fire resistance. It can last upto 10 years. Recommended exchanged after 5 years of use or when ever it is due.
- When Brass-Brass connections are used gas tight connections can be obtained at <3NM force. Connections of Zinc - Steel - Brass needs 12-18NM! and are therefore not recommended.
- All Hose assemblies can be supplied with steel/ stainless steel

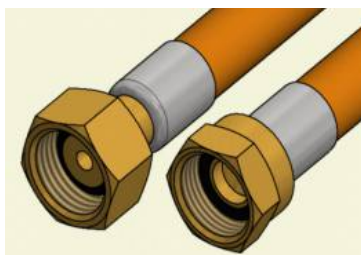

Connections: each side x Length	Main Material	Hose dims	Notes	Factory	IGT DK
				Item No.	Item No.
G1/2-RH nut x M20*1.5 nut x 1500mm	PVC*brass	8x3.5 mm	EN16436	SBPR.080.2.150.15	S008-154
G1/2RH - G1/4" LH x 1500mm	PVC*brass	6.3x3.5mm	EN16436	SBPR.080.2.150.15	S006-509

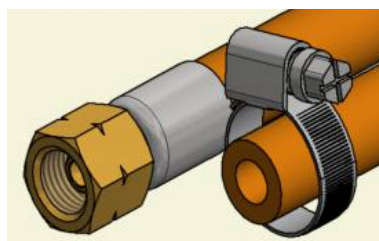

Connections: each side x Length	Main Material	Hose dims	Notes	Factory	IGT DK
				Item No.	Item No.
G1/4"-LH nut x clamp x 550m	PVC*brass	8x3.5 mm	EN16436	SBPR.080.1.055.01	S008-056

PVC HOSE - LOW PRESSURE ASSEMBLY (CLASS 2)

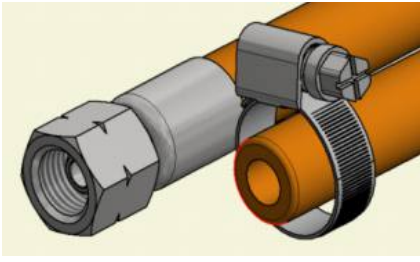

Connections: each side x Length	Main Material	Hose dims	Notes	Factory	IGT DK
				Item No.	Item No.
G1/4"-LH nut x clamp x 1500mm	PVC*steel, white zinc plating	8x3.5 mm	EN16436	SBPR.080.1.150.07	S008-155

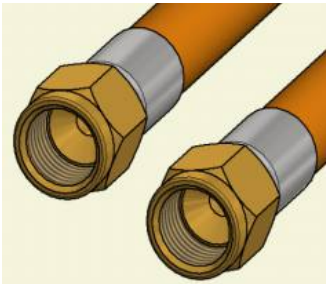

Connections: each side x Length	Main Material	Hose dims	Notes	Factory	IGT DK
				Item No.	Item No.
5/8" UNF nut x 5/8"UNF nut x 450mm	PVC*brass	8x3.5 mm	EN16436	SBPR.080.2.045.01	S008-045

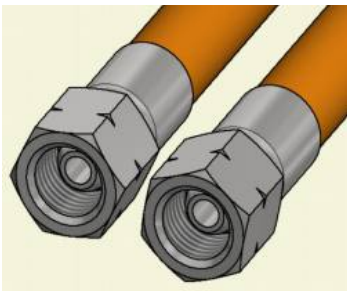

Connections: each side x Length	Main Material	Hose dims	Notes	Factory	IGT DK
				Item No.	Item No.
G1/4"-LH nut x G1/4"-LH nut x 400 mm	PVC*steel, white zinc plating	6.3 x 3.5 mm	EN16436	SBPR.063.2.040.01	S006-060
G1/4"-LH nut x G1/4"-LH nut x 600 mm	PVC*steel, white zinc plating	6.3 x 3.5 mm	EN16436	SBPR.063.2.060.01	S006-510
G1/4"-LH nut x G1/4"-LH nut x 700 mm	PVC*sBrass	6.3 x 3.5 mm	EN16436	SBPR.063.2.080.01	S006-081
G1/4"-LH nut x G1/4"-LH nut x 800 mm	PVC*Brass	6.3 x 3.5 mm	EN16436	SBPR.080.1.100.07	S006-094
G1/4"-LH nut x G1/4"-LH nut x 2000mm	PVC*Steel	6.3 x 3.5 mm	EN16436	SBPR.063.2.150.02	S006-202
G1/4"-LH nut x G1/4"-LH nut x 1500 mm	PVC*Brass	6.3 x 3.5 mm	EN16436	SBPR.063.2.060.01	S006-095
G1/4"-LH nut x G1/4"-LH nut x 1200 mm	PVC*Brass	6.3 x 3.5 mm	EN16436	SBPR.063.2.080.01	S006-120
G1/4"-LH nut x G1/4"-LH nut x 3000 mm	PVC* Brass	6.3 x 3.5 mm	EN16436	SBPR.080.1.100.07	S006-306
G1/4"-LH nut x G1/4"-LH nut x 5000mm	PVC* Brass	6.3 x 3.5 mm	EN16436	SBPR.063.2.150.02	S006-306

PVC HOSE - LOW PRESSURE ASSEMBLY (CLASS 2)

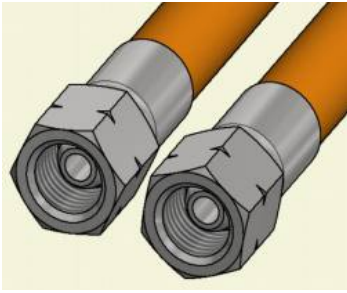

Connections: each side x Length	Main Material	Hose dims	Notes	Factory	IGT DK
				Item No.	Item No.
G1/4"-LH nut x G1/4"-LH nut x 2000mm	PVC*steel, white zinc plating	6.3 x 3.5 mm	EN16436	SDPR.063.2.200.11	S006-202
G1/4"-LH nut x G1/4"-LH nut x 1500mm	PVC*steel, white zinc plating	6.3 x 3.5 mm	EN16436	SBPR.063.2.150.11	S006-150
G1/4"-LH nut x G1/4"-LH nut x 2000mm	PVC*steel, white zinc plating	8 x 3.5 mm	EN16436	SBPR.080.2.200.04	S008-200
G3/8"-LH nut x G3/8"-LH nut x 2000mm	PVC*steel	6.3 x 3.5 mm	EN16436	SBPR.063.2.150.01	S006-508

● FRENCH HOSE ASSEMBLIES Other length than below stated are not allowed.



Connections: each side x Length	Main Material	Hose dims	Notes	Factory	IGT DK
				Item No.	Item No.
M20x1,5 RH X G1/2" RH x 500mm	PVC	8 X 3.5	NF36110		S036 110 050
M20x1,5 RH X G1/2" RH x 750mm	PVC	8 X 3.5	NF36110		S036 110 075
M20x1,5 RH X G1/2" RH x 1000mm	PVC	8 X 3.5	NF36110		S036 110 100
M20x1,5 RH X G1/2" RH x 1250mm	PVC	8 X 3.5	NF36110		S036 110 125
M20x1,5 RH X G1/2" RH x 1500mm	PVC	8 X 3.5	NF36110		S036 110 150

RUBBER HOSE - LOW PRESSURE ASSEMBLY (CLASS 2)

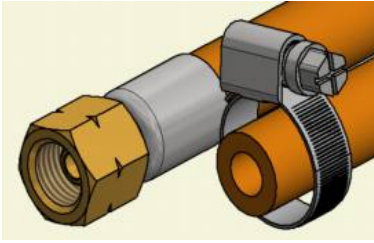

- To connect fittings, consuming appliances and piping
- Cold-resistant to -30°C
- CLASS 2 EN16436

Connections: each side x Length	Main Material	Hose dims	Notes	Factory	IGT DK
				Item No.	Item No.
G1/4"-LH nut x 900mm	Rubber*steel, white zinc plating	8 x 3.5 mm	EN16436	SERO.080.1.090.01	S006-090

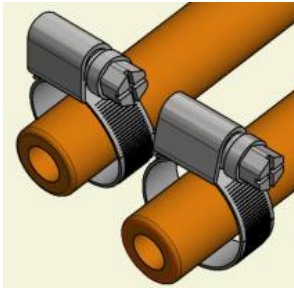

Connections: each side x Length	Main Material	Hose dims	Notes	Factory	IGT DK
				Item No.	Item No.
Clamp on each end x 600mm	Rubber/Steel	8 x 3.5 mm	EN16436	SERO.080.0.060.02	S006-063
Clamp on each end x 1000mm	Rubber/Steel	10x 3.5 mm	EN16436	SERO.100.0.100.02	S006-100

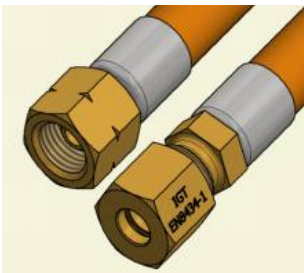

Connections: each side x Length	Main Material	Hose dims	Notes	Factory	IGT DK
				Item No.	Item No.
G 1/4 Lh nut x compression fitting 8 x 400mm	Rubber/Brass	6.3x3.5 mm	EN16436	SERO.063.2.040.06	S006-C001
G 1/4 Lh nut x compression fitting 10 x 400mm	Rubber/Brass	6.3x3.5 mm	EN16436	SERO.063.2.040.07	S006-C002
G 1/4 Lh nut x compression fitting 8 x 600mm	Rubber/Brass	6.3x3.5 mm	EN16436		S006-C003
G 1/4 Lh nut x compression fitting 10 x 1200mm	Rubber/Brass	6.3x3.5 mm	EN16436		S006-C006
G 1/4 Lh nut x compression fitting 10 x 800mm	Rubber/Brass	6.3x3.5 mm	EN16436		S006-C007

RUBBER HOSE - LOW PRESSURE ASSEMBLY (CLASS 2)

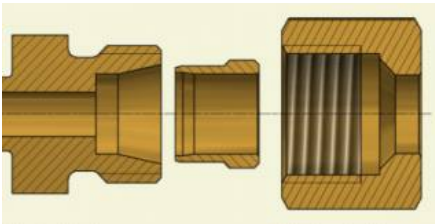

Compression fitting to EN8434

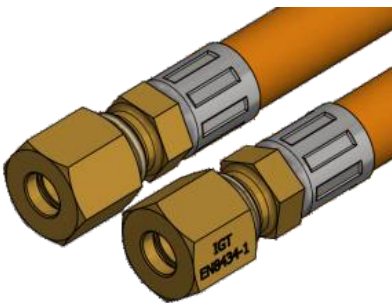

Connections: each side x Length	Main Material	Hose dims	Notes	Factory	IGT DK
				Item No.	Item No.
compression fitting 8 x 8 MM tube x 300mm	Rubber/Brass	6.3x3.5 mm	EN16436		S006-C008
compression fitting 8 x 8 MM tube x 450mm	Rubber/Brass	6.3x3.5 mm	EN16436		S006-C004
compression fitting 8 x 8 MM tube x 600mm	Rubber/Brass	6.3x3.5 mm	EN16436		S006-C005

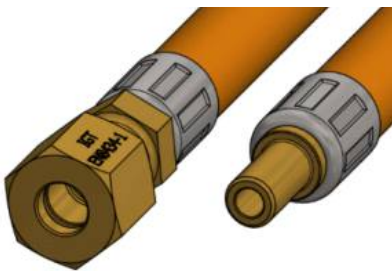

Connections: each side x Length	Main Material	Hose dims	Notes	Factory	IGT DK
				Item No.	Item No.
compression fitting 8 x 8 MM tube x 400mm	Rubber/Brass	6.3x3.5 mm	EN16436		S006-C105
compression fitting 8 mm x 8 mm tube 8 x 1200mm	Rubber/Brass	6.3x3.5 mm	EN16436		S006-C103

RUBBER HOSE - LOW PRESSURE ASSEMBLY (CLASS 2)



Connections: each side x Length	Main Material	Hose dims	Notes	Factory	IGT DK
				Item No.	Item No.
8 mm tube x 8 mm tube x 400mm	Rubber/Brass	6.3x3.5 mm	EN16436		S006-C123
8 mm tube x 8 mm tube x 800mm	Rubber/Brass	6.3x3.5 mm	EN16436		S006-C120
8 mm tube x 8 mm tube x 1500mm	Rubber/Brass	6.3x3.5 mm	EN16436		S006-C121
8 mm tube x 8 mm tube x 1000mm	Rubber/Brass	6.3x3.5 mm	ENA16436		S006-C122

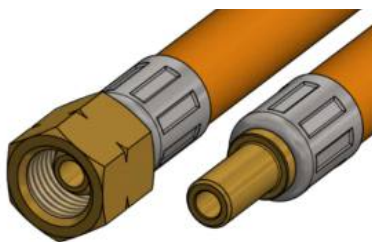

Connections: each side x Length	Main Material	Hose dims	Notes	Factory	IGT DK
				Item No.	Item No.
G 1/4 Lh nut x 8 mm tube x 400mm	Rubber/Brass	6.3x3.5 mm	EN16436		S006-C104
G 1/4 Lh nut x 8 mm tube x 600mm	Rubber/Brass	6.3x3.5 mm	EN16436		S006-C101
G 1/4 Lh nut x 8 mm tube x 800mm	Rubber/Brass	6.3x3.5 mm	EN16436		S006-C107
G 1/4 Lh nut x 8 mm tube x 1200mm	Rubber/Brass	6.3x3.5 mm	EN16436		S006-C102
G 1/4" x 10 mm tube x 400mm	Rubber/Brass	6.3x3.5 mm	EN16436		S006-C106

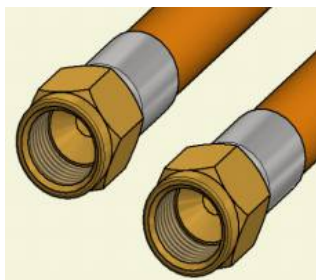

Connections: each side x Length	Main Material	Hose dims	Notes	Factory	IGT DK
				Item No.	Item No.
5/8" UNF nut x 5/8"UNF nut x 460mm	Rubber/Brass	6.3x3.5 mm	EN16436	SERO.080.2.046.01	S006-046

RUBBER HOSE - LOW PRESSURE ASSEMBLY (CLASS 2)

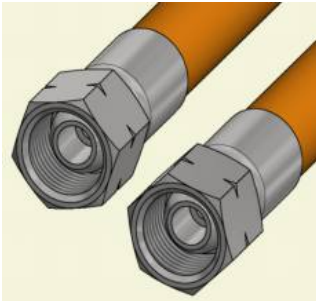

Connections: each side x Length	Main Material	Hose dims	Notes	Factory	IGT DK
				Item No.	Item No.
G3/8"-LH nut x G3/8"-LH nut x 2000 mm	Rubber*steel, white zinc plating	6.3 x 3.5 mm	EN16436	SERO.063.2.200.05	
G3/8"-LH nut x G3/8"-LH nut x 2000 mm	Rubber*steel, white zinc plating	6.3 x 3.5 mm	EN16436	SERO.063.2.200.06	
G3/8"-LH nut x G3/8"-LH nut x 3000 mm	Rubber*steel, white zinc plating	6.3 x 3.5 mm	EN16436	SERO.063.2.300.01	
G1/4"-LH nut x G1/4"-LH nut x 1500mm	Rubber*steel, white zinc plating	6.3 x 3.5 mm	EN16436	SBPR.063.2.150.03	
G1/4"-LH nut x G1/4"-LH nut x 400mm	Rubber*steel, white zinc plating	6.3 x 3.5 mm	EN16436	SERO.063.2.040.01	

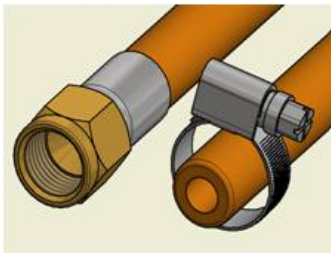

Connections: each side x Length	Main Material	Hose dims	Notes	Factory	IGT DK
				Item No.	Item No.
5/8"-18 UNF nut x clamp x 800mm	Rubber*brass	6.3 x 3.5 mm	EN16436	SERO.080.1.080.01	S006-085
5/8"-18 UNF nut x clamp x 600mm	Rubber*brass	6.3 x 3.5 mm	EN16436	SERO.080.1.080.02	S006-065
5/8"-18 UNF x 1/4"LH x 800mm	Rubber*brass	6.3 x 3.5 mm	EN16436	SERO.080.1.080.02	S006-083
5/8"-18 UNF x 1/4"LH x 2500mm	Rubber*brass	6.3 x 3.5 mm	EN16436	SERO.080.1.080.02	S006-251

RUBBER HOSE - LOW PRESSURE ASSEMBLY (CLASS 2)

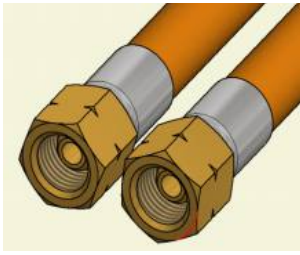

Connections: each side x Length	Main Material	Hose dims	Notes	Factory	IGT DK
				Item No.	Item No.
G1/4"-LH nut x G1/4"-LH nut x500 mm	Rubber*brass	6.3 x 3.5 mm	EN 16436 Phthalate Reach	SERO.063.2.050.01	S006-053
G1/4"-LH nut x G1/4"-LH nut x600 mm	Rubber*brass	6.3 x 3.5 mm	EN 16436 Phthalate Reach	SERO.063.2.050.03	S006-062
G1/4"-LH nut x G1/4"-LH nut x700 mm	Rubber*brass	6.3 x 3.5 mm	EN 16436 Phthalate Reach	SERO.063.2.080.06	S006-511
G1/4"-LH nut x G1/4"-LH nut x800 mm	Rubber*brass	6.3 x 3.5 mm	EN 16436 Phthalate Reach	SERO.063.2.080.06	S006-082
G1/4"-LH nut x G1/4"-LH nut x1000 mm	Rubber*brass	6.3 x 3.5 mm	EN 16436 Phthalate Reach	SERO.063.2.080.06	S006-109
G1/4"-LH nut x G1/4"-LH nut x1500 mm	Rubber*brass	6.3 x 3.5 mm	EN 16436 Phthalate Reach	SERO.063.2.080.06	S006-153



Connections: each side x Length	Main Material	Hose dims	Notes	Factory	IGT DK
				Item No.	Item No.
G1/4"-LH nut -90 degree x G1/4"-LH nut x500 mm	Rubber*brass	6.3 x 3.5 mm	EN 16436 Phthalate Reach		S006-054
G1/4"-LH nut - 90 degree x G1/4"-LH nut x800 mm	Rubber*brass	6.3 x 3.5 mm	EN 16436 Phthalate Reach		S006-084

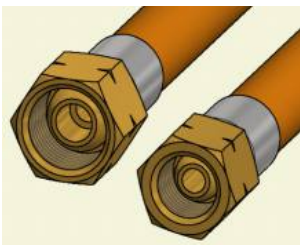

Connections: each side x Length	Main Material	Hose dims	Notes	Factory	IGT DK
				Item No.	Item No.
G3/8"-LH nut xG1/4"-LH nut x1200mm	Rubber*brass	6.3 x 3.5 mm	EN16436	SERO.063.2.120.06	S006-122

- To connect fittings, consuming appliances and piping
- Cold-resistant to -30°C

HIGH PRESSURE ASSEMBLY (CLASS 3)

- To connect fittings, consuming appliances and piping
- Cold-resistant to -30°C
- Pull force to detach fitting >300 kg.

- 100 % factory gas leak tested at 20 bar.
- Leak tight -30°C- +50°C



Connections: each side x Length	Main Material	Hose dims	Notes	Factory	IGT DK
				Item No.	Item No.
G2 female to G2 female x 500mm	Rubber	8 x 5 mm	EN16436		S008-HP070
G2 female to G2 female x 1000mm	Rubber	8 x 5 mm	EN16436		S008-HP130

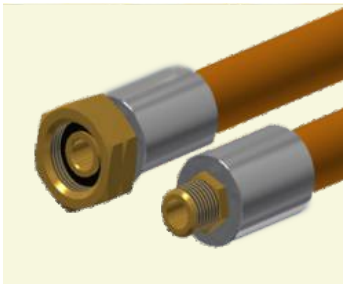

Connections: each side x Length	Main Material	Hose dims	Notes	Factory	IGT DK
				Item No.	Item No.
G2 female to 1/4"NPT - 1/4"NPT x 800mm	Rubber	8 x 5 mm	EN16436		S008-HP 080
G2 female to 1/4"NPT - M20x45 x 800mm	Rubber	8 x 5 mm	EN16436		S008-HP 081

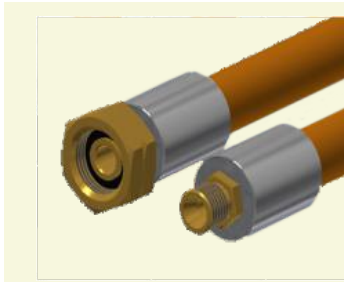

Connections: each side x Length	Main Material	Hose dims	Notes	Factory	IGT DK
				Item No.	Item No.
G2 female to G1/4 LH male x 1000	Rubber	8 x 5 mm	EN16436		S008-HP 100

HIGH PRESSURE ASSEMBLY (CLASS 3)

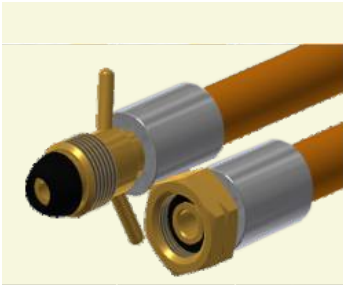

Connections: each side x Length	Main Material	Hose dims	Notes	Factory	IGT DK
				Item No.	Item No.
G2 female to POL x 1000mm	Rubber	8 x 5 mm	EN16436		S008-HP101

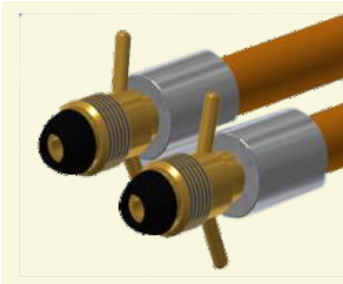

Connections: each side x Length	Main Material	Hose dims	Notes	Factory	IGT DK
				Item No.	Item No.
POL to POL x 1000mm	Rubber	8 x 5 mm	EN16436		S008-HP102
POL to POL x 400mm	Rubber	8 x 5 mm	EN16436		S008-HP103

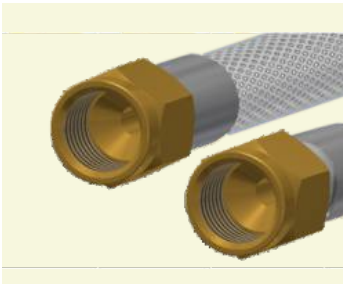

Connections: each side x Length	Main Material	Hose dims	Notes	Factory	IGT DK
				Item No.	Item No.
Stainless steel braided hose x 1000mm 5/8"UNF female to 5/8"UNF female		8 x 3.5 mm			S008-HPB100

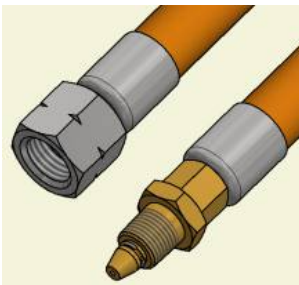

Connections: each side x Length	Main Material	Hose dims	Notes	Factory	IGT DK
				Item No.	Item No.
G3/8" -LH nut x 1/8"NPT x 800mm	Rubber*brass	6.3x5	EN16436		S006-085
G3/8" -LH nut x 1/8"NPT x 1200mm	Rubber*brass	6.3x5	EN16436		S006-123

HIGH PRESSURE ASSEMBLY (CLASS 3)

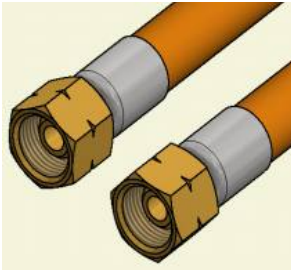

Connections: each side x Length	Main Material	Hose dims	Notes	Factory	IGT DK
				Item No.	Item No.
G3/8"-LH nut xG3/8"-LH nut x 1000mm	Rubber*brass	6.3 x 3.5 mm	EN 16436	SERO.063.2.150.02	S006-108
G3/8"-LH nut xG3/8"-LH nut x 1500mm	Rubber*brass	8 x 3.5 mm	EN 16436	SERO.080.2.150.09	S006-154
G3/8"-LH nut xG3/8"-LH nut x 1500mm	Rubber*brass	8 x 3.5 mm	En16436, for Chile	SERO.080.2.150.09	S006-158
G3/8"-LH nut xG3/8"-LH nut x 2000mm	Rubber*brass	6.3 x 3.5 mm	EN 16436	SERO.063.2.080.04	S006-203
G3/8"-LH nut xG3/8"-LH nut x 3000mm	Rubber*brass	6.3x3.5 mm	EN16436	SBPR.063.2.150.07	S006-305
G3/8"-LH nut xG3/8"-LH nut x 5000mm	Rubber*brass	6.3x3.5 mm	EN16436	SBPR.063.2.200.03	S006-502
G3/8"-LH nut xG3/8"-LH nut x 10000mm	Rubber*brass	6.3x3.5 mm	EN16436	SBPR.063.2.200.01	S006-1000

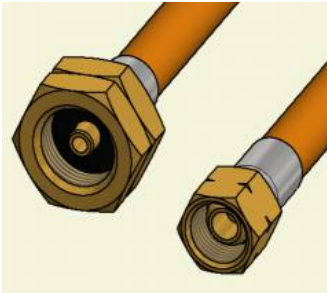

Connections: each side x Length	Main Material	Hose dims	Notes	Factory	IGT DK
				Item No.	Item No.
G3/8" LH nut x G5 LH nut x 5000 mm	Rubber*brass	6.3 x 3.5 mm	En16436 G5 = W21.8x1.814	SERO.063.2.500.05	S006-506
G3/8" LH nut x G5 LH nut x 1200 mm	Rubber*brass	6.3 x 3.5 mm	En16436 G5 = W21.8x1.814	SERO.063.2.500.05	S006-600

PIGTAILS - HIGH PRESSURE ASSEMBLY (CLASS 3)

- Pigtails with built in excess flow valve, needle valve or ball valve.
- Any inlet and outlet combination, any length.
- Rubber hose made to EN16436 class 3, 30 bar-, optional steel braided.
- PVC hose made to U1144
- To connect fittings, consuming appliances and piping

Technical data:

- cold-resistant to -30°C
- Pull force to detach fitting >300 kg.
- 100 % factory gas leak tested at 20 bar.
- Leak tight -30°C- +50°C



Connections: each side x Length	Main connection material	Hose dims.	Hose dims.	Factory Item No.	IGT DK Item No.
G10-M20x1,5	Brass	ID 6,3 mm	450 mm		S006-HP-450-002



Connections: each side x Length	Main connection material	Hose dims.	Hose dims.	Factory Item No.	IGT DK Item No.
G5-M20x1,5	Brass	ID 6,3 mm	450 mm		S006-HP-450-003



Connections: each side x Length	Main connection material	Hose dims.	Hose dims.	Factory Item No.	IGT DK Item No.
G7-M20x1,5	Brass	ID 6,3 mm	450 mm		S006-HP-450-004

PIGTAILS - HIGH PRESSURE ASSEMBLY (CLASS 3)



Connections: each side x Length	Main connection material	Hose dims.	Hose dims.	Factory	IGT DK
				Item No.	Item No.
G8-M20x1,5	Brass	ID 6,3 mm	450 mm		S006-HP-450-001



Connections: each side x Length	Main connection material	Hose dims.	Hose dims.	Factory	IGT DK
				Item No.	Item No.
G2-M20x1,5	Brass	ID 6,3 mm	450 mm		S006-HP-450-005



Connections: each side x Length	Main connection material	Hose dims.	Hose dims.	Factory	IGT DK
				Item No.	Item No.
G2-M20x1,5	Brass	ID 6,3 mm	450 mm		S006-HP-450-006

PIGTAILS

- *US hose assemblies with built in needle valve*



IGT DK

Description	Item No.
Connections each side: 1" ACME L = 5ft	S008 - US700
Connections each side: POL L = 5ft	S008 - US701

- *Manual change over Pigtailed designed for A900-V006 and A900-V007. Twist and tension free pigtailed.*

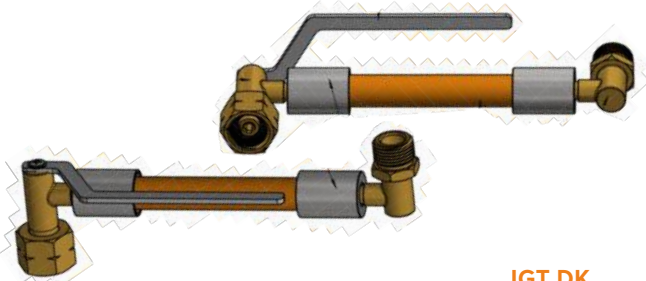

IGT DK

Hose dims.	Hose dims.	Type	Item No.
G4 W21,8	G4-W21,8 Male	LPG	S006-HP300

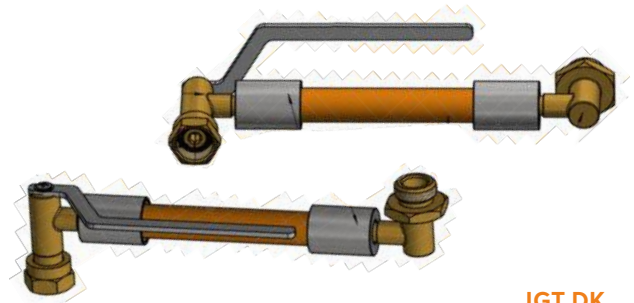

IGT DK

Hose dims.	Hose dims.	Type	Item No.
M20x1,5	G2-W21,8 Male	LPG	S006-HP301



IGT DK

Description	Type	Item No.
Rubber Hose Pigtail G2 - POL G10 Class 3 Heavy Sleeve	LPG	S008-HP101



IGT DK

Description	Type	Item No.
Rubber Hose Pigtail POL G10 - POL G10 Class 3 Heavy Sleeve	LPG	S008-HP102

BRASS TUBE



- *En1057 Seamless*

Description	Outer diameter	Wall thickness	Length	Material	Factory	IGT DK
					Item No.	Item No.
Copper tube to EN	Ø8 mm	0,8 mm		Copper		H900-100
Copper tube to EN	Ø10 mm	0,8 mm		Copper		H900-101

- *Copper Tube Clip*



IGT DK

Description	Item No.
8mm Copper pipe clips	V200-150
10mm Copper pipe clips	V200-151

STEEL HOSE



IGT

Description	Length	Material		Product code
European Gas Hose According To EN 14800:2007	500mm	Hose : AISI 304L Stainless Steel	DN12	PF 14800 050
European Gas Hose According To EN 14800:2007	750mm	Braid : AISI 304 Stainless Steel Wire	DN12	PF 14800 075
European Gas Hose According To EN 14800:2007	1000mm	Sleeve : AISI 304 Stainless Steel	DN12	PF 14800 100
European Gas Hose According To EN 14800:2007	1250mm	Fittings : AISI303, Brass Nut Cover : PVC	DN12	PF 14800 125
European Gas Hose According To EN 14800:2007	1500mm	Gasket: Nitrile Rubber (EN 549 Standard)	DN12	PF 14800 150
European Gas Hose According To EN 14800:2007	2000mm	Max. Working Pressure : 0,5 bar	DN12	PF 14800 200



IGT

Description	Length	Material		Product code
European Gas Hose According To EN 14800:2008	500mm	Hose : AISI 304L Stainless Steel	DN12	PF 14800 050
European Gas Hose According To EN 14800:2008	750mm	Braid : AISI 304 Stainless Steel Wire	DN12	PF 14800 075
European Gas Hose According To EN 14800:2008	1000mm	Sleeve : AISI 304 Stainless Steel	DN12	PF 14800 100
European Gas Hose According To EN 14800:2008	1250mm	Fittings : AISI303, Brass Nut Cover : PVC	DN12	PF 14800 125
European Gas Hose According To EN 14800:2008	1500mm	Gasket: Nitrile Rubber (EN 549 Standard)	DN12	PF 14800 150
European Gas Hose According To EN 14800:2008	2000mm	Max. Working Pressure : 0,5 bar	DN12	PF 14800 200

HOSE (CLASS 2)

- EN16436 Class 2 10 bar hose in PVC and Rubber
- To connect fittings, consuming appliances and piping

Technical data:

- cold-resistant to -30°C

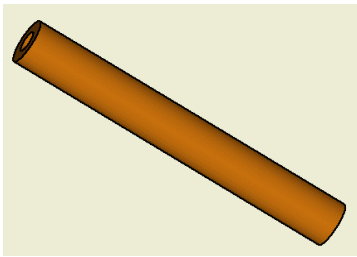

Connections: each side x Length	Main Material	Hose dims	Notes	Factory	IGT DK
				Item No.	Item No.
50 meters	Rubber	8 x 3.5 mm	EN16436	SERO.080.0.000.01	S008-000N
100M	PVC	8 x 3.5 mm	EN16V36	H00000E022	S008-005
1 meter	PVC	8 x 3.5 mm	EN16436	SBPR.080.0.061.02	S008-061
1 meter	Rubber	8 x 3.5 mm	EN16436	SERO.080.0.100.03	S008-100
100 meters	Rubber	10 x 5,0mm	EN16436	H00000E027	S010-000N

HOSE PVC REINFORCED BY STEEL WIRE

- *Ø8 mm or ø10 mm, wall thicknes 6 mm +-0,5 mm.
Working pressure 2 bar- Burst pressure 40 bar.*



Description	Material	Coil length	Diameter	Factory	IGT DK
				Item No.	Item No.
LPG hose made to standard KGS1906, PVC	Steel Reinforced	50 meters	Ø8 mm		S008-K100
LPG hose made to standard KGS1906, PVC	Steel Reinforced	50 meters	Ø10 mm		S010-K100

IGT Standard Blister Card and Blister Packaging



● A900ZK0001 65X115mm



● IGT Blister with larger part



● Sample Blister with small part



● IGT Blister with small part

TYPES OF THREADS: BSP THREADS

IGT uses standard EN ISO 228-1 to produce threads of the standard catalogue brass fittings for threaded tube and pipe. This type of thread is also known as BSP parallel thread (cylindrical) or "Gas" thread (G).

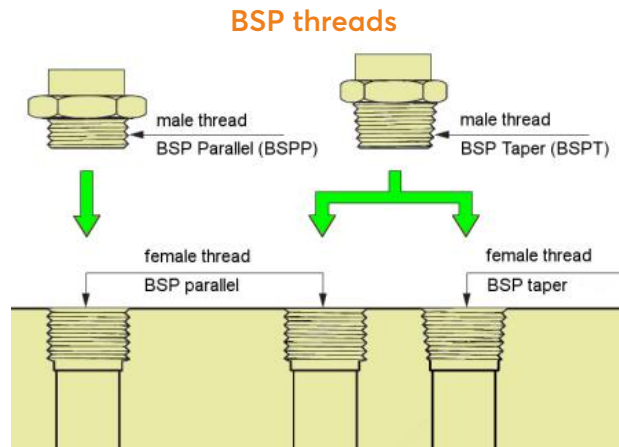

The **cylindrical thread** to ISO 228-1 is a type of Whitworth thread, a name derived from the inventor of it and whose origins date back to England in the mid-nineteenth century. Whitworth shape is based on a thread with thread angle of 55 degrees, with rounded crests and roots. This type of thread became the most widely used for connecting threaded pipe and emerged as the de facto British Standard, which became known as standard threaded British pipe or BSP (for its acronym: British Standard Pipe), in two variants: conical (BSPT, t "tapered"), and in its parallel or cylindrical shape (BSP, the last p of "parallel").

As mentioned, the **BSP threads** are threads with profile "Gas" and can be of two types:

- **Parallel:** male and the female are mounted on the same cylindrical thread. Denomination according to ISO 228-1 is G.

Denomination example: 1/2" thread BSP parallel → **G 1/2**.

- **Tapered:** the conical male can be installed on a female thread conical or parallel. Denomination following ISO 7-1 (EN 10226-1) is R for external thread (male) and Rp and Rc for internal thread (female), with Rp if cylindrical and Rc when conical.

Denomination example: male thread 1/2" BSP tapered → **R 1/2**

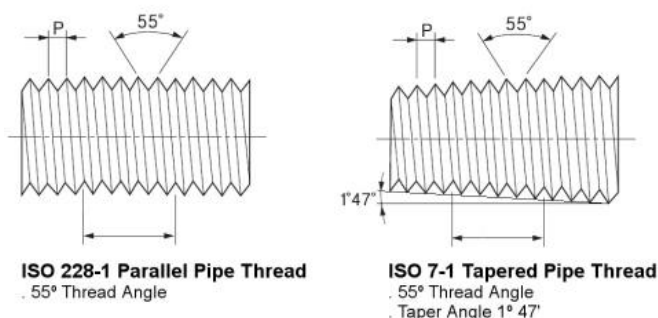

IGT we also manufacture conical threads on request, according to standard ISO 7-1 or others, such as the American standard NPT (National Pipe Thread), which also defines conical thread and we will talk some other time. Please contact us if it is your case and you need manufacture on request according to your specifications.

For more technical information you can ask us or refer directly to the rules:

- EN ISO 228-1: Pipe threads where pressure tight joints are not made on the threads. Part 1: Dimensions, tolerances and designation.
- EN 10226-1: Pipe threads where pressure tight joints are made on the threads. Part 1: Taper external threads and parallel internal threads. Dimensions, tolerances and designation.



"Striving for perfection"
this motto summarizes how
we focus on maximizing
domestic gas safety.



**INTEGRATED GAS
TECHNOLOGIES**

Denmark

HEAD OFFICE IN DENMARK
INTEGRATED GAS TECHNOLOGIES
Gydevang 39-41 DK-3450 Allerød Denmark
Tel: 0045-4576 9921 | Fax: 0045-4576 9821
E: sales@igt-lpg.com | W: www.igt-lpg.com

FACTORY IN CHINA
NINGBO SHUAI XIAN REGULATOR CO. LTD
No 566, Jinshan Road, Zone C, Investment center
Jiangbei District, Ningbo Zhejiang, China
E: sales@igct-lpg.com | W: www.igct-lpg.com

FACTORY IN INDIA
INTEGRATED GAS CONTROLS TECHNOLOGIES PVT. LTD
Survey No.784, 14-59/3A,
Medchal Village, Near Ravalkole
"X" Road, Medchal Mandal
& Medchal - Makajgir District.
E: sales@igct-lpg.com | W: www.igct-lpg.com

